

# FIMCO

INDUSTRIES



**2024 CATALOG & PARTS BOOK**

# FIMCO INDUSTRIES: A BRIEF INTRODUCTION



*FIMCO has been a national leader in lawn & garden products for over 60 years. Our rich history and manufacturing expertise helps us stand apart as an industry innovator who builds durable, reliable and functional products that our customers demand. For decades we have lead the way in developing the first dedicated UTV sprayers, small scale spot sprayers, and pull type lawn attachments such as aerators, de-thatchers, trailer carts and more. If you aren't familiar with the FIMCO family of products, please find us online at [fimcoindustries.com](http://fimcoindustries.com) and see how you can trust FIMCO with all of your lawn & garden needs.*

**THE BEST BUILT LAWN & GARDEN PRODUCTS IN AMERICA. PERIOD.**

# INDEX

## A

Ace Pumps.....	85-86
Accessories for Gauges .....	96
Accessories, Pump.....	82-83
Accessories, Tank .....	70,109
Additives, Tank.....	81
Agitators, Tank .....	109
AR Pumps .....	87
AR Diaphragm Pump & Kits.....	87
ATV Mounted Sprayers .....	27-33,52-53

## B

Bodies, Nozzle .....	92,110
Boom Assemblies .....	72-74
Broadcast Nozzles .....	71-74,78,123,125,127

## C

Calibration Container .....	128
Caps, Nozzle .....	68-69,93,106-107
Centrifugal Pumps.....	84-86
Color Coded Tips .....	111-121,123
Couplers, Pump & PTO.....	82-83

## D

Diaphragm Check Valve Nozzles .....	106,110
Diaphragm Pumps, AR.....	87
Drop Pipes & Swivels.....	108
Dry Material Spreader, ATV .....	56-57
Dry Material Spreader, ATV Pull Behind .....	58-59
Dry Material Spreader, 3 Point Hitch.....	60
Dry Material Spreader, Truck Hitch .....	56

## E

Electric Diaphragm Pump (12 Volt).....	76-77
Electric Valves .....	101-102
Electric Sprayer Controls.....	101
EPDM, EVA and PVC Sprayer Hoses.....	95

## F

Fitting Nylon, Pipe.....	88-93
Foam For Marker.....	81

## G

Gasoline Engine Driven Pumps .....	87
Gasoline Engine Skid Sprayers .....	47-50
Gauge Isolator Kit.....	96
Gauges.....	96
Gauges Accessories.....	96

## H

Hitch (3 Point) Sprayers .....	38-46
Hose Assemblies .....	95
Hose Barbs .....	71,90-93,98
Hose Clamps.....	95
Hose & Pipe Cutter.....	95
Hose Reels.....	80
Hose for Sprayer .....	95
Hypro Centrifugal Pumps .....	84
Hypro Roller Pump .....	82-83
Hypro Roller Pump Repairs .....	82-83

## K

Kit, Gauge Isolator.....	96
Kits, Spray Wands.....	78-79
Kits, Pump Repair (Roller Pump).....	82-83

## L

Lawn Attachments .....	61-67
Lawn Rollers .....	61
Line Strainers.....	99-100

## M

Manifolds .....	71,104
Multifunction Sprayer .....	4
Multi-Lid.....	75

## N

Nozzle Components .....	110-115
Nozzles .....	115-125, 127
Nylon Quick Couplers for Hoses.....	97
Nylon Fittings .....	88-94
Nylon Hose Inserts .....	94-95

## P

Packaged Parts .....	68-69,70-71
Poly Hose Couplers (Banjo Camlever).....	98
Polypropylene Hose Inserts .....	94
Polypropylene Fittings.....	88-94
Polypropylene Quick Couplers for Hose .....	94
Polypropylene Spray Wands .....	133
Pressure Relief Valves .....	104-105
Pro Series Spot Sprayer.....	51
Pro Series ATV Sprayers .....	52-53
Pro Series 3PT Sprayer .....	54
Pro Series Trailer Sprayers .....	55
Pump Accessories.....	82-83
Pump Repair Kits.....	70,82-83
Pumps.....	76-77,82-87

## R

Remote Control Kit (Remote Switch).....	75
Roller, Lawn.....	61
Row Crop Sprayers .....	44-46

## S

Screen, Nozzle .....	106
Selector Valves, Boom.....	101-103
Shipping Information.....	138-139
Shut Off Valves .....	97-98
Skid Sprayers (Lawn & Garden).....	47
Skid Mounted Sprayers (Ag.).....	48-50
Skid Mounted Commercial Sprayers.....	48-50
Spot Sprayers .....	4-17,51
Spray Wands .....	5, 78-79
Spray Wands & Parts.....	5,70,78-79,129-135
Spray Wand Kits .....	78-79
Spray Wand, Lithium Ion Powered .....	5,79
Spray Nozzle Parts.....	106
Spray Tips, Off-Center .....	126
Sprayer Controls.....	101
Sprayer Hoses.....	95
Sprayer Selector Valves.....	102-103
Spraying Information.....	136-137
Strainer, Line .....	99-100
Swivels, Connector .....	107-108

## T

Tank Accessories .....	70,75,109
Tank Cleaning Agent.....	81
Tank Repair Parts .....	70
TeeJet Tips.....	111-127
Three Point Hitch Sprayers .....	38-46,54
Tips, Nozzles.....	111-127
Trailer Carts.....	64-67
Trailer Type Sprayers Lawn & Garden.....	18-26,55

## U

UTV Sprayer .....	34-37
-------------------	-------

## V

Valves, Boom.....	101-105
Valve, Diaphragm Check (for Nozzles) .....	110
Valve, Electric.....	101-102
Valve, Pressure Relief.....	104-105
Valves, Shut-Off.....	97-98

## W

Wand, High Pressure.....	130,134
Weights & Measurements .....	138-139
Wheeled Spot Sprayers.....	4,6-7



# 4 GALLON PORTABLE SPOT SPRAYER



### BEST IN CLASS PUMP

- Rechargeable Lithium Ion Spray Wand
- 65 Minute Run Time / Charge
- 10 ft Vertical Spray, 20 ft Horizontal Spray



### REINFORCED STEEL HANDLE

- Durable Build
- Premium Materials

**4 GALLON TANK**

### SUPERIOR TANK STRENGTH

- High Density Polyethylene Tank with UV Stabilizer
- Delivers Years of Dependable Use



### BACKPACK STRAPS

- Fully Adjustable Strap Length
- Attached To Tank For Backpack Carry



### RECHARGEABLE BATTERY

- Rechargeable Lithium Ion Battery
- 3.6V Charger Included
- 2.5 Hour Recharge Time



**LWN-GRD-4**

Sprayer Weight	Water Weight	Sprayer W/Water Weight
20 lbs	33 lbs	53 lbs

Model #	Code #	Tank Size	Shipping Weight	Carton Size	Shipping Class	Cubic Feet	Ship Via	UPC Code
LWN-GRD-4	5303079	4 Gallon	11#	14 x 11 x 23	150	2.1	GROUND	733029119995



# LITHIUM ION POWERED SPRAY WAND PUMP



## BEST IN CLASS PUMP

- Rechargeable Lithium Ion Spray Wand
- 65 Minute Run Time / Charge
- Includes 3.6V Charger
- 10 ft Vertical Spray, 20 ft Horizontal Spray

## NO MORE PUMPING

Easily Upgrade Your Pump-Up  
Sprayer To A Lithium Ion  
Powered Sprayer For  
Effortless Spraying



SPRAYER & HOSE  
NOT INCLUDED

Model #	Code #	UPC Code
7772105	7772105	733029120212



# 5 GALLON WHEELED SPOT SPRAYER



**HIGHFLO**  
HIGH PERFORMANCE

### BEST IN CLASS PUMP

- 1.2 GPM High Performance 12 Volt Pump
- Maximum Pressure Of 60 PSI
- Pressure Switch Turns Pump On & Off
- Self Priming
- Can Run Dry Without Damage
- Chemical Resistant Components
- Fan Cooled To Promote Longevity & Efficiency

**5 GALLON TANK**

### SUPERIOR TANK STRENGTH

- High Density Polyethylene Tank with UV Stabilizer
- Delivers Years of Dependable Use

### RECHARGABLE PORTABLE POWER

12 Volt Rechargeable Battery with Charger.



### LEVER GRIP SPRAY WAND

- Up To 25 Feet Horizontal Spray
- Up To 15 Feet Vertical Spray
- Adjustable Spray Pattern



### 15 FEET OF 3/8 INCH HOSE

- Chemical Resistant Rubber Hose
- Easy To Wrap For Storage
- Less Prone To Kinking

**LG-5-P**

Sprayer Weight	Water Weight	Sprayer W/Water Weight
36 lbs	42 lbs	78 lbs

Model #	Code #	Tank Size	Shipping Weight	Carton Size	Shipping Class	Cubic Feet	Ship Via	UPC Code
LG-5-P	5302165	5 Gallon	33#	22 x 17 x 22	150	4.8	GROUND	733029002211



# 8 GALLON WHEELED SPOT SPRAYER



**HIGHFLO**  
HIGH PERFORMANCE

## BEST IN CLASS PUMP

- 1.2 GPM High Performance 12 Volt Pump
- Maximum Pressure Of 60 PSI
- Pressure Switch Turns Pump On & Off
- Self Priming
- Can Run Dry Without Damage
- Chemical Resistant Components
- Fan Cooled To Promote Longevity & Efficiency

**8 GALLON TANK**

## SUPERIOR TANK STRENGTH

- High Density Polyethylene Tank with UV Stabilizer
- Delivers Years of Dependable Use

## RECHARGABLE PORTABLE POWER

12 Volt Rechargeable Battery with Charger.



## LEVER GRIP SPRAY WAND

- Up To 25 Feet Horizontal Spray
- Up To 15 Feet Vertical Spray
- Adjustable Spray Pattern



## 15 FEET OF COILED HOSE

- Chemical Resistant Polyurethane Hose
- Coils for Easy Storage
- Provides Up To 30 Feet of Spraying Diameter

**LG-8-P**

Sprayer Weight	Water Weight	Sprayer W/Water Weight
23 lbs	67 lbs	90 lbs

Model #	Code #	Tank Size	Shipping Weight	Carton Size	Shipping Class	Cubic Feet	Ship Via	UPC Code
LG-8-P	5302164	8 Gallon	26#	19 x 17 x 23	150	4.3	GROUND	733029007841



# 15 TO 25 GALLON SPOT SPRAYER

**CONSUMER  
1 YEAR  
WARRANTY  
COMMERCIAL  
90 DAYS**



## 12 VOLT PUMP



- 1.0 GPM 12 Volt Electric Pump
- Maximum Pressure Of 60 PSI
- Pressure Switch Turns Pump On & Off
- Self Priming
- Fuse Protected
- Can Run Dry Without Damage
- 1 Year Pump Warranty

## FUSE PROTECTED 8 FT LEAD WIRE



- Helps Protect Your Vehicle Wiring
- Alligator Clips & On/Off Switch Included

## 5 INCH TANK LID



- Lid Tethered To Tank
- Splash Prevention Flap In Lid
- Venting Reduces Tank Pressure

## IN TANK / INLINE STRAINER



- 3/8 Inch Hose Barb Connection
- Minimizes Chemical Waste

## LEVER GRIP SPRAY WAND



- Up To 20 Feet Horizontal Spray
- Up To 12 Feet Vertical Spray
- Adjustable Spray Pattern

## 15 FEET OF 3/8 INCH HOSE



- Chemical Resistant Rubber Hose
- Easy To Wrap For Storage
- Less Prone To Kinking

**SOLD AS A 9 PACK (15-SP-GS-B)  
OR AS A SINGLE UNIT BOX (15-SP-GS)**

## 15-SP-GS & 25-SP-GS

Model #	Code #	Tank Size	Shipping Weight	Carton Size	Shipping Class	Cubic Feet	Ship Via	UPC Code
15-SP-GS-B*	5303643	15 Gallon	140#	47 X 33 X 40	150	35.9	LTL	733029124753
15-SP-GS	5303644	15 Gallon	14#	32 X 15 X 14.75	150	4.1	GROUND	733029124760
25-SP-GS	5303645	25 Gallon	20#	32 X 14.75 X 20.25	150	5.5	GROUND	733029124777

\* Only Available in Bulk Packaging of 9 in Multiples of 18. Minimum Order of 18.







# 10 TO 30 GALLON STANDARD SPOT SPRAYERS



**HIGHFLO**  
HIGH PERFORMANCE

### BEST IN CLASS PUMP

- 1.2 GPM High Performance 12 Volt Pump
- Maximum Pressure Of 60 PSI
- Pressure Switch Turns Pump On & Off
- Self Priming
- Can Run Dry Without Damage
- Chemical Resistant Components
- Fan Cooled To Promote Longevity & Efficiency



### LEVER GRIP SPRAY WAND

- Up To 25 Feet Horizontal Spray
- Up To 15 Feet Vertical Spray
- Adjustable Spray Pattern



### FUSE PROTECTED 8 FT LEAD WIRE

- Helps Protect Your Vehicle Wiring
- Alligator Clips & On/Off Switch Included



### 15 FEET OF 3/8 INCH HOSE

- Chemical Resistant Rubber Hose
- Easy To Wrap For Storage
- Less Prone To Kinking

## LG-10-EC, LG-15-EC, LG-20-EC, LG-25-EC, LG-30-EC

Sprayer Model	Sprayer Weight	Water Weight	Sprayer W/Water Weight
LG-10-EC	13 lbs	83 lbs	96 lbs
LG-15-EC	14 lbs	125 lbs	139 lbs
LG-20-EC	16 lbs	167 lbs	183 lbs
LG-25-EC	18 lbs	209 lbs	227 lbs
LG-30-EC	21 lbs	250 lbs	271 lbs

Model #	Code #	Tank Size	Shipping Weight	Carton Size	Shipping Class	Cubic Feet	Ship Via	UPC Code
LG-10-EC	5301547	10 Gallon	12#	31 x 14 x 12	150	3.1	GROUND	733029005250
LG-15-EC	5301302	15 Gallon	15#	34 x 14 x 16	150	4.5	GROUND	733029003058
LG-20-EC	5301548	20 Gallon	20#	38 x 18 x 15	150	6.0	GROUND	733029005267
LG-25-EC	5301378	25 Gallon	23#	40 x 16 x 19	150	7.1	GROUND	733029003195
LG-30-EC	5301561	30 Gallon	74#	42 x 19 x 16	150	8	GROUND	733029005472



# 15 TO 30 GALLON SPOT SPRAYERS



**HIGHFLO**  
HIGH PERFORMANCE

### BEST IN CLASS PUMP

- 2.4 GPM High Performance 12 Volt Pump
- Maximum Pressure Of 60 PSI
- Pressure Switch Turns Pump On & Off
- Self Priming
- Can Run Dry Without Damage
- Chemical Resistant Components
- Fan Cooled To Promote Longevity & Efficiency



### FUSE PROTECTED 8 FT LEAD WIRE

- Helps Protect Your Vehicle Wiring
- Alligator Clips & On/Off Switch Included



**LG-28-S**  
**LG-30-S**

### DELUXE PISTOL GRIP SPRAY WAND

- Up To 40 Feet Horizontal Spray
- Up To 25 Feet Vertical Spray
- Adjustable Spray Pattern



**LG-13-P**  
**LG-29-P**

### LEVER GRIP SPRAY WAND

- Up To 30 Feet Horizontal Spray
- Up To 16 Feet Vertical Spray
- Adjustable Spray Pattern



### 15 FEET OF 3/8 INCH HOSE

- Chemical Resistant Rubber Hose
- Easy To Wrap For Storage
- Less Prone To Kinking

## LG-13-P, LG-29-P, LG-28-S, LG-30-S

Sprayer Model	Sprayer Weight	Water Weight	Sprayer W/Water Weight
LG-13-P	16 lbs	125 lbs	141 lbs
LG-29-P	20 lbs	209 lbs	229 lbs
LG-28-S	21 lbs	209 lbs	230 lbs
LG-30-S	24 lbs	250 lbs	274 lbs

Model #	Code #	Tank Size	Shipping Weight	Carton Size	Shipping Class	Cubic Feet	Ship Via	UPC Code
LG-13-P	5300393	15 Gallon	18#	34 x 14 x 16	150	4.5	GROUND	733029001009
LG-29-P	5300632	25 Gallon	24#	40 x 16 x 19	150	7.1	GROUND	733029001443
LG-28-S	5301063	25 Gallon	24#	40 x 16 x 19	150	7.1	GROUND	733029002310
LG-30-S	5301478	30 Gallon	28#	42 x 19 x 16	150	7.4	GROUND	733029004246



# 15 & 25 GALLON SPOT SPRAYERS



**HIGHFLO**  
HIGH PERFORMANCE

### BEST IN CLASS PUMP

- 2.4 GPM High Performance 12 Volt Pump
- Maximum Pressure Of 60 PSI
- Pressure Switch Turns Pump On & Off
- Self Priming
- Can Run Dry Without Damage
- Chemical Resistant Components
- Fan Cooled To Promote Longevity & Efficiency



### MANIFOLD W/PRESSURE GAUGE

- Lever Ball Valves Allow Flow & Pressure Control
- Easily Monitor Pressure With Highly Visible Gauge
- Quick Connect Fittings Enables Fast Configuration



### LEVER GRIP SPRAY WAND

- Up To 30 Feet Horizontal Spray
- Up To 16 Feet Vertical Spray
- Adjustable Spray Pattern



### 15 FEET OF 3/8 INCH HOSE

- Chemical Resistant Rubber Hose
- Easy To Wrap For Storage
- Less Prone To Kinking



### FUSE PROTECTED 8 FT LEAD WIRE

- Helps Protect Your Vehicle Wiring
- Alligator Clips & On/Off Switch Included

## LG-14-PM & LG-25-PM

Sprayer Model	Sprayer Weight	Water Weight	Sprayer W/Water Weight
LG-14-PM	16 lbs	125 lbs	141 lbs
LG-25-PM	22 lbs	209 lbs	231 lbs

Model #	Code #	Tank Size	Shipping Weight	Carton Size	Shipping Class	Cubic Feet	Ship Via	UPC Code
LG-14-PM	5301144	15 Gallon	18#	34 x 14 x 16	150	4.5	GROUND	733029002549
LG-25-PM	5301146	25 Gallon	24#	40 x 16 x 19	150	7.1	GROUND	733029002563



# 15 & 25 GALLON SPOT SPRAYERS



**HIGHFLO**  
HIGH PERFORMANCE

### BEST IN CLASS PUMP

- 2.4 GPM High Performance 12 Volt Pump
- Maximum Pressure Of 60 PSI
- Pressure Switch Turns Pump On & Off
- Self Priming
- Can Run Dry Without Damage
- Chemical Resistant Components
- Fan Cooled To Promote Longevity & Efficiency



### MANIFOLD W/PRESSURE GAUGE

- Lever Ball Valves Allow Flow & Pressure Control
- Easily Monitor Pressure With Highly Visible Gauge
- Quick Connect Fittings Enables Fast Configuration



### DELUXE PISTOL GRIP SPRAY WAND

- Up To 40 Feet Horizontal Spray
- Up To 25 Feet Vertical Spray
- Adjustable Spray Pattern



### 15 FEET OF 3/8 INCH HOSE

- Chemical Resistant Rubber Hose
- Easy To Wrap For Storage
- Less Prone To Kinking



### FUSE PROTECTED 8 FT LEAD WIRE

- Helps Protect Your Vehicle Wiring
- Alligator Clips & On/Off Switch Included

## LG-14-SM & LG-25-SM

Sprayer Model	Sprayer Weight	Water Weight	Sprayer W/Water Weight
LG-14-SM	16 lbs	125 lbs	141 lbs
LG-25-SM	21 lbs	209 lbs	230 lbs

Model #	Code #	Tank Size	Shipping Weight	Carton Size	Shipping Class	Cubic Feet	Ship Via	UPC Code
LG-14-SM	5301145	15 Gallon	18#	34 x 14 x 16	150	4.5	GROUND	733029002556
LG-25-SM	5301147	25 Gallon	24#	40 x 16 x 19	150	7.1	GROUND	733029002570



# 25 GALLON SPOT SPRAYER



**HIGHFLO**  
HIGH PERFORMANCE

### BEST IN CLASS PUMP

- 4.5 GPM High Performance 12 Volt Pump
- Maximum Pressure Of 60 PSI
- Pressure Switch Turns Pump On & Off
- Self Priming
- Can Run Dry Without Damage
- Chemical Resistant Components
- Fan Cooled To Promote Longevity & Efficiency



### MANIFOLD W/PRESSURE GAUGE

- Lever Ball Valves Allow Flow & Pressure Control
- Easily Monitor Pressure With Highly Visible Gauge
- Quick Connect Fittings Enables Fast Configuration



### DELUXE PISTOL GRIP SPRAY WAND

- Up To 40 Feet Horizontal Spray
- Up To 28 Feet Vertical Spray
- Adjustable Spray Pattern



### 15 FEET OF 3/8 INCH HOSE

- Chemical Resistant Rubber Hose
- Easy To Wrap For Storage
- Less Prone To Kinking



### FUSE PROTECTED 8 FT LEAD WIRE

- Helps Protect Your Vehicle Wiring
- Alligator Clips & On/Off Switch Included

## LG-25-HV

Sprayer Weight	Water Weight	Sprayer W/Water Weight
22 lbs	209 lbs	231 lbs

Model #	Code #	Tank Size	Shipping Weight	Carton Size	Shipping Class	Cubic Feet	Ship Via	UPC Code
LG-25-HV	5301222	25 Gallon	24#	40 x 16 x 19	150	7.1	GROUND	733029002990



# 40 GALLON DELUXE SPOT SPRAYER



**HIGHFLO**  
HIGH PERFORMANCE

### BEST IN CLASS PUMP

- 2.4 GPM High Performance 12 Volt Pump
- Maximum Pressure Of 60 PSI
- Pressure Switch Turns Pump On & Off
- Self Priming
- Can Run Dry Without Damage
- Chemical Resistant Components
- Fan Cooled To Promote Longevity & Efficiency



### FUSE PROTECTED 8 FT LEAD WIRE

- Helps Protect Your Vehicle Wiring
- Alligator Clips & On/Off Switch Included



### DELUXE PISTOL GRIP SPRAY WAND

- Up To 40 Feet Horizontal Spray
- Up To 25 Feet Vertical Spray
- Adjustable Spray Pattern



### 15 FEET OF 3/8 INCH HOSE

- Chemical Resistant Rubber Hose
- Easy To Wrap For Storage
- Less Prone To Kinking

## LG-40-DLX

Sprayer Weight	Water Weight	Sprayer W/Water Weight
28 lbs	334 lbs	362 lbs

Model #	Code #	Tank Size	Shipping Weight	Carton Size	Shipping Class	Cubic Feet	Ship Via	UPC Code
LG-40-DLX	5302186	40 Gallon	30#	30 x 20 x 24	150	8.4	GROUND	733029107336



# 45 GALLON SPOT SPRAYER



**SPRAYER  
1 YEAR  
WARRANTY  
PUMP  
2 YEAR**



**HIGHFLO**  
HIGH PERFORMANCE

### BEST IN CLASS PUMP

- 4.5 GPM High Performance 12 Volt Pump
- Maximum Pressure Of 60 PSI
- Pressure Switch Turns Pump On & Off
- Self Priming - Can Run Dry Without Damage
- Fuse Protected
- Chemical Resistant Components
- Fan Cooled To Promote Longevity & Efficiency



### DELUXE PISTOL GRIP SPRAY WAND

- Up To 40 Feet Horizontal Spray
- Up To 28 Feet Vertical Spray
- Adjustable Spray Pattern



### MANIFOLD W/PRESSURE GAUGE

- Lever Ball Valves Allow Flow & Pressure Control
- Easily Monitor Pressure With Highly Visible Gauge
- Quick Connect Fittings Enables Fast Configuration



### 25 FEET OF 3/8 INCH HOSE

- Chemical Resistant Rubber Hose
- Easy To Wrap For Storage
- Less Prone To Kinking



### FUSE PROTECTED 8 FT LEAD WIRE

- Helps Protect Your Vehicle Wiring
- Alligator Clips & On/Off Switch Included



### 5 INCH TANK LID

- Lid Tethered To Tank
- Splash Prevention Flap In Lid
- Venting Reduces Tank Pressure

## LG-45-SS

Sprayer Weight	Water Weight	Sprayer W/Water Weight
32 lbs	375 lbs	407 lbs

Model #	Code #	Tank Size	Shipping Weight	Carton Size	Shipping Class	Cubic Feet	Ship Via	UPC Code
LG-45-SS	5303260	45 Gallon	32#	37.5 X 23.25 X 21.5	150	10.8	GROUND	733029123800



# 65 GALLON SPOT SPRAYER



**HIGHFLO**  
HIGH PERFORMANCE

### BEST IN CLASS PUMP

- 4.5 GPM High Performance 12 Volt Pump
- Maximum Pressure Of 60 PSI
- Pressure Switch Turns Pump On & Off
- Self Priming - Can Run Dry Without Damage
- Fuse Protected
- Chemical Resistant Components
- Fan Cooled To Promote Longevity & Efficiency



### 22" HIGH PRESSURE SPRAY WAND

- Ergonomic Design Lends To Less Fatigue
- Up To 38 Ft Horizontal & 27 Ft Vertical Spray
- Adjustable Spray Pattern



### MANIFOLD W/PRESSURE GAUGE

- Lever Ball Valves Allow Flow & Pressure Control
- Easily Monitor Pressure With Highly Visible Gauge
- Quick Connect Fittings Enables Fast Configuration



### 25 FEET OF 3/8 INCH HOSE

- Chemical Resistant Rubber Hose
- Easy To Wrap For Storage
- Less Prone To Kinking



### 5 INCH TANK LID

- Lid Tethered To Tank
- Splash Prevention Flap In Lid
- Venting Reduces Tank Pressure



### FUSE PROTECTED 8 FT LEAD WIRE

- Helps Protect Your Vehicle Wiring
- Alligator Clips & On/Off Switch Included

## LG-65-HP

Sprayer Weight	Water Weight	Sprayer W/Water Weight
40 lbs	542 lbs	582 lbs

Model #	Code #	Tank Size	Shipping Weight	Carton Size	Shipping Class	Cubic Feet	Ship Via	UPC Code
LG-65-HP	5303623	65 Gallon	40#	44.25 X 25.25 X 23.5	150	15.2	GROUND	733029123824





# BRUSH SPOT SPRAYERS



**DESIGNED TO CONTROL TOUGHER INVASIVE SPECIES SUCH AS WOODY PLANTS AND VINES.**



### BEST IN CLASS PUMP

- 2.2 GPM Pro Series 12 Volt Pump
- Maximum Pressure Of 100 PSI
- For Use With Oil-Water Emulsions, Oil Based Products And Harsh Chemicals
- Self Priming
- Can Run Dry Without Damage



### 15 FEET OF 3/8 INCH HOSE

- Chemical Resistant Rubber Hose
- Easy To Wrap For Storage
- Less Prone To Kinking



### FUSE PROTECTED 8 FT LEAD WIRE

- Helps Protect Your Vehicle Wiring
- Alligator Clips & On/Off Switch Included



### LEVER GRIP SPRAY WAND

- Up To 30 Feet Horizontal Spray
- Up To 20 Feet Vertical Spray
- Adjustable Spray Pattern

## BR-15-SP-EC, BR-25-SP-EC & BR-40-SP-EC

Sprayer Model	Sprayer Weight	Water Weight	Sprayer W/Water Weight
BR-15-SP-EC	15 lbs	125 lbs	140 lbs
BR-25-SP-EC	18 lbs	209 lbs	227 lbs
BR-40-SP-EC	19 lbs	334 lbs	353 lbs

Model #	Code #	Tank Size	Shipping Weight	Carton Size	Shipping Class	Cubic Feet	Ship Via	UPC Code
BR-15-SP-EC	5303152	15 Gallon	18#	32 x 15 x 16	150	4.4	GROUND	733029121561
BR-25-SP-EC	5303153	25 Gallon	24#	32 x 15 x 21	150	5.9	GROUND	733029120755
BR-40-SP-EC	5303154	40 Gallon	22#	30 x 20 x 24	150	8.3	GROUND	733029121578



# 2-NOZZLE TRAILER SPRAYERS



15 Gallon 2-Nozzle Trailer Sprayer



**HIGHFLO**  
HIGH PERFORMANCE

### BEST IN CLASS PUMP

- 1.2 GPM High Performance 12 Volt Pump
- Maximum Pressure Of 60 PSI
- Pressure Switch Turns Pump On/Off As Needed
- Self Priming
- Can Run Dry Without Damage
- Chemical Resistant Components
- Fan Cooled To Promote Longevity & Efficiency



### LEVER GRIP SPRAY WAND

- Up To 25 Feet Horizontal Spray
- Up To 15 Feet Vertical Spray
- Adjustable Spray Pattern



### 15 FEET OF 3/8 INCH HOSE

- Chemical Resistant Rubber Hose
- Remains Flexible
- Less Prone To Kinking



### FUSE PROTECTED 8 FT LEAD WIRE

- Industry Leader In Safety
- Protects Vehicle Wiring
- Clips And On / Off Switch Included

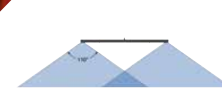

### 2-NOZZLE RIGID STEEL BOOM

- 2-Nozzle Boom Delivers 7 Feet Of Spray Coverage



### Y MANIFOLD

- Lever Ball Valves Allow Flow & Pressure Control
- Garden Hose Threading Enables Fast Configuration



### TURF TIRES

- 12" Diameter Pneumatic Turf Tires
- 5/8" Solid Steel Axle
- Sealed Ball Bearings

## 15-2N-TRL-GS & 25-2N-TRL-GS

Sprayer Model	Sprayer Weight	Water Weight	Sprayer W/Water Weight
25-2N-TRL-GS	40 lbs	209 lbs	249 lbs
15-2N-TRL-GS	38 lbs	125 lbs	163 lbs

Model #	Code #	Tank Size	Shipping Weight	Carton Size	Shipping Class	Cubic Feet	Ship Via	UPC Code
15-2N-TRL-GS	5303198	15 Gallon	38#	40 X 15.75 X 15	150	5.5	GROUND	733029122056
25-2N-TRL-GS	5303199	25 Gallon	40#	40 X 15.75 X 21.25	150	7.7	GROUND	733029122063

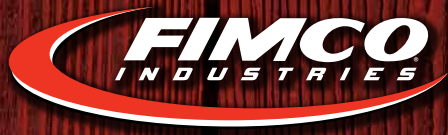

# 25 GALLON 3-NOZZLE TRAILER SPRAYER

**SPRAYER  
1 YEAR  
WARRANTY  
PUMP  
2 YEAR**



**HIGHFLO**  
HIGH PERFORMANCE

### BEST IN CLASS PUMP

- 2.4 GPM High Performance 12 Volt Pump
- Maximum Pressure Of 60 PSI
- Pressure Switch Turns Pump On & Off
- Self Priming - Can Run Dry Without Damage
- Fuse Protected
- Chemical Resistant Components
- Fan Cooled To Promote Longevity & Efficiency



### 15 FEET OF 3/8 INCH HOSE

- Chemical Resistant Rubber Hose
- Remains Flexible
- Less Prone To Kinking



### PREMIUM SPRAY TIPS

- TeeJet Turbo Floodjet TF-VP3
- Reduces Chemical Drift
- Includes Check Valve Strainer



### FUSE PROTECTED 8 FT LEAD WIRE

- Helps Protect Your Vehicle Wiring
- Alligator Clips & On/Off Switch Included



### 3-NOZZLE FOLDING STEEL BOOM

- Delivers 10 Feet of Spray Coverage
- 40 Inch Nozzle Spacing
- 82" Folding Steel Boom



### MANIFOLD W/PRESSURE GAUGE

- Lever Ball Valves Allow Flow & Pressure Control
- Easily Monitor Pressure With Highly Visible Gauge
- Quick Connect Fittings Enables Fast Configuration



### TURF TIRES

- 12" Diameter Pneumatic Turf Tires
- 5/8" Solid Steel Axle
- Sealed Ball Bearings



### LEVER GRIP SPRAY WAND

- Up To 30 Feet Horizontal Spray
- Up To 16 Feet Vertical Spray
- Adjustable Spray Pattern

## 25-3N-TRL-GS

Sprayer Weight	Water Weight	Sprayer W/Water Weight
43 lbs	209 lbs	252 lbs

Model #	Code #	Tank Size	Shipping Weight	Carton Size	Shipping Class	Cubic Feet	Ship Via	UPC Code
25-3N-TRL-GS	5303649	25 Gallon	43#	40 X 15.75 X 21.25	150	7.7	GROUND	733029124784



# 20 GALLON 2-NOZZLE TRAILER SPRAYER



**SPRAYER  
1 YEAR  
WARRANTY  
PUMP  
2 YEAR**



**HIGHFLO**  
HIGH PERFORMANCE

### BEST IN CLASS PUMP

- 2.4 GPM High Performance 12 Volt Pump
- Maximum Pressure Of 60 PSI
- Pressure Switch Turns Pump On & Off
- Self Priming
- Can Run Dry Without Damage
- Chemical Resistant Components
- Fan Cooled To Promote Longevity & Efficiency



### MANIFOLD W/PRESSURE GAUGE

- Lever Ball Valves Allow Flow & Pressure Control
- Easily Monitor Pressure With Highly Visible Gauge
- Quick Connect Fittings Enables Fast Configuration



### FUSE PROTECTED 8 FT LEAD WIRE

- Helps Protect Your Vehicle Wiring
- Alligator Clips & On/Off Switch Included
- Includes 5 foot lead wire extension



### INNOVATIVE BREAK AWAY BOOM

- Boom Folds Backwards If Striking An Obstacle
- Boom Folds Forward For Compact Storage



### DELUXE PISTOL GRIP SPRAY WAND

- Up To 40 Feet Horizontal Spray
- Up To 25 Feet Vertical Spray
- Adjustable Spray Pattern



### 15 FEET OF 3/8 INCH HOSE

- Chemical Resistant Rubber Hose
- Easy To Wrap For Storage
- Less Prone To Kinking



### PREMIUM SPRAY TIPS

- Premium Wide Angle Tips
- Reduces Chemical Drift
- Includes Anti-Drip Strainer

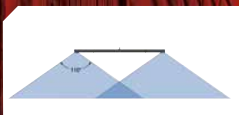

### 2-NOZZLE BREAKAWAY STEEL BOOM

- 2-Nozzle Boom Delivers 7 Feet Of Spray Coverage
- Folding Steel Boom



### TURF TIRES

- 12" Diameter Pneumatic Turf Tires
- 5/8" Solid Steel Axle
- Sealed Ball Bearings

## LG-20-TRL

Sprayer Weight	Water Weight	Sprayer W/Water Weight
51 lbs	167 lbs	218 lbs

Model #	Code #	Tank Size	Shipping Weight	Carton Size	Shipping Class	Cubic Feet	Ship Via	UPC Code
LG-20-TRL	5302316	20 Gallon	46#	36 x 20 x 17	150	7.1	GROUND	733029110008



# 30 GALLON 2-NOZZLE TRAILER SPRAYER



**HIGHFLO**  
HIGH PERFORMANCE

### BEST IN CLASS PUMP

- 2.4 GPM High Performance 12 Volt Pump
- Maximum Pressure Of 60 PSI
- Pressure Switch Turns Pump On & Off
- Self Priming
- Can Run Dry Without Damage
- Chemical Resistant Components
- Fan Cooled To Promote Longevity & Efficiency



### MANIFOLD W/PRESSURE GAUGE

- Lever Ball Valves Allow Flow & Pressure Control
- Easily Monitor Pressure With Highly Visible Gauge
- Quick Connect Fittings Enables Fast Configuration



### FUSE PROTECTED 8 FT LEAD WIRE

- Helps Protect Your Vehicle Wiring
- Alligator Clips & On/Off Switch Included
- Includes 5 foot lead wire extension



### INNOVATIVE BREAK AWAY BOOM

- Boom Folds Backwards If Striking An Obstacle
- Boom Folds Forward For Compact Storage



### DELUXE PISTOL GRIP SPRAY WAND

- Up To 40 Feet Horizontal Spray
- Up To 25 Feet Vertical Spray
- Adjustable Spray Pattern



### 15 FEET OF 3/8 INCH HOSE

- Chemical Resistant Rubber Hose
- Easy To Wrap For Storage
- Less Prone To Kinking



### PREMIUM SPRAY TIPS

- Premium Wide Angle Tips
- Reduces Chemical Drift
- Includes Anti-Drip Strainer

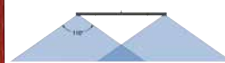

### 2-NOZZLE BREAKAWAY STEEL BOOM

- 2- Nozzle Boom Delivers 7 Feet Of Spray Coverage
- Foldable Steel Boom



### TURF TIRES

- 16" Diameter Pneumatic Turf Tires
- 3/4" Solid Steel Axle
- Heavy Duty Roller Bearings

## LG-30-TRL

Sprayer Weight	Water Weight	Sprayer W/Water Weight
58 lbs	250 lbs	313 lbs

Model #	Code #	Tank Size	Shipping Weight	Carton Size	Shipping Class	Cubic Feet	Ship Via	UPC Code
LG-30-TRL	5302317	30 Gallon	62#	45 x 20 x 20	150	11	GROUND	733029110015



# 45 GALLON 4-NOZZLE 12V TRAILER SPRAYER

**SPRAYER  
1 YEAR  
WARRANTY  
PUMP  
2 YEAR**



**HIGH FLO  
HIGH PERFORMANCE**

### BEST IN CLASS PUMP

- 2.4 GPM High Performance 12 Volt Pump
- Maximum Pressure Of 60 PSI
- Pressure Switch Turns Pump On & Off
- Self Priming - Can Run Dry Without Damage
- Fuse Protected
- Chemical Resistant Components
- Fan Cooled To Promote Longevity & Efficiency



### 25 FEET OF 3/8 INCH HOSE

- Chemical Resistant Rubber Hose
- Easy To Wrap For Storage
- Less Prone To Kinking



### MANIFOLD W/PRESSURE GAUGE

- Lever Ball Valves Allow Flow & Pressure Control
- Easily Monitor Pressure With Highly Visible Gauge
- Quick Connect Fittings Enables Fast Configuration



### PREMIUM SPRAY TIPS

- TeeJet AIXR11002 Air Induction XR Flat Spray Tips
- Reduces Chemical Drift
- Includes Check Valve Strainer



### FUSE PROTECTED 8 FT LEAD WIRE

- Helps Protect Your Vehicle Wiring
- Alligator Clips & On/Off Switch Included
- Includes 5 foot lead wire extension



### 4-NOZZLE FOLDING STEEL BOOM

- 4-Nozzle Boom
- Delivers 10 Feet Of Spray Coverage
- Folding Steel Boom



### DELUXE PISTOL GRIP SPRAY WAND

- Up To 40 Feet Horizontal Spray
- Up To 25 Feet Vertical Spray
- Adjustable Spray Pattern



### TURF TIRES

- 16" Diameter Pneumatic Turf Tires
- 3/4" Solid Steel Axle
- Heavy Duty Roller Bearings

## TRL-45-12V-4

Sprayer Weight	Water Weight	Sprayer W/Water Weight
103 lbs	375 lbs	478 lbs

Model #	Code #	Tank Size	Shipping Weight	Carton Size	Shipping Class	Cubic Feet	Ship Via	UPC Code
TRL-45-12V-4	5303635	45 Gallon	103#	39.75 X 23.5 X 25.5	150	13.8	GROUND	733029124135

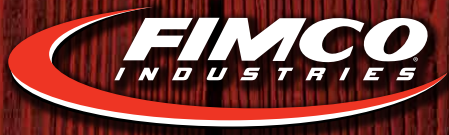

# 65 GALLON 12V TRAILER SPRAYERS



65 Gallon 3-Nozzle Broadcast Trailer Sprayer



**HIGHFLO**  
HIGH PERFORMANCE

## BEST IN CLASS PUMP

- 4.5 GPM High Performance 12 Volt Pump
- Maximum Pressure Of 60 PSI
- Pressure Switch Turns Pump On & Off
- Self Priming - Can Run Dry Without Damage
- Fuse Protected
- Chemical Resistant Components
- Fan Cooled To Promote Longevity & Efficiency



## 25 FEET OF 3/8 INCH HOSE

- Chemical Resistant Rubber Hose
- Easy To Wrap For Storage
- Less Prone To Kinking



## MANIFOLD W/PRESSURE GAUGE

- Lever Ball Valves Allow Flow & Pressure Control
- Easily Monitor Pressure With Highly Visible Gauge
- Quick Connect Fittings Enables Fast Configuration



## FUSE PROTECTED 8 FT LEAD WIRE

- Helps Protect Your Vehicle Wiring
- Alligator Clips & On/Off Switch Included
- Includes 5 foot lead wire extension



## TURF TIRES

- 18" Diameter x 8.5" Wide Pneumatic Turf Tire
- 1" Solid Steel Axle
- Heavy Duty Greaseable Roller Bearings

## AVAILABLE BOOM OPTIONS

### 3-NOZZLE BROADCAST

- 36 Foot Spray Coverage
- Each Nozzle Sprays Independently

### 7-NOZZLE BOOM

- 12 Feet Spray Coverage
- Folding Steel Boom

## DELUXE PISTOL GRIP SPRAY WAND



- Up To 40 Feet Horizontal Spray
- Up To 28 Feet Vertical Spray
- Adjustable Spray Pattern

## TRL-65-12V-BL & TRL-12V-65-7

Sprayer Model	Sprayer Weight	Water Weight	Sprayer W/Water Weight
TRL-65-12V-BL	137 lbs	542 lbs	679 lbs
TRL-65-12V-7	153 lbs	542 lbs	695 lbs

Model #	Code #	Tank Size	Shipping Weight	Carton Size	Shipping Class	Cubic Feet	Ship Via	UPC Code
TRL-65-12V-BL	5303638	65 Gallon	137#	46 X 34.25 X 28.25	150	25.8	LTL	733029124470
TRL-65-12V-7	5303637	65 Gallon	153#	46 X 34.25 X 28.25	150	25.8	LTL	733029124463



# 65 GALLON GAS TRAILER SPRAYERS



65 Gallon 7-Nozzle Trailer Sprayer



## BRIGGS & STRATTON ENGINE

- 127cc Gas Engine
- 4 Roller Pump - 6 GPM
- Pressure Relief Valve
- 2" 0-200 PSI Dry Gauge
- Suction Line Sump
- 3/4 Inch Black Poly Strainer



## 25 FEET OF 3/8 INCH HOSE

- Chemical Resistant Rubber Hose
- Easy To Wrap For Storage
- Less Prone To Kinking



## TURF TIRES

- 18" Diameter x 8.5" Wide Pneumatic Turf Tire
- 1" Solid Steel Axle
- Heavy Duty Greaseable Roller Bearings

## AVAILABLE BOOM OPTIONS

### 3-NOZZLE BROADCAST

- 36 Foot Spray Coverage
- Each Nozzle Sprays Independently

### 7-NOZZLE BOOM

- 12 Feet Spray Coverage
- Folding Steel Boom



## DELUXE PISTOL GRIP SPRAY WAND

- Up To 45 Feet Horizontal Spray
- Up To 30 Feet Vertical Spray
- Adjustable Spray Pattern

## TRL-65-4R-BL & TRL-65-4R-7

Sprayer Model	Sprayer Weight	Water Weight	Sprayer W/Water Weight
TRL-65-4R-BL	214 lbs	542 lbs	756 lbs
TRL-65-4R-7	230 lbs	542 lbs	772 lbs

Model #	Code #	Tank Size	Shipping Weight	Carton Size	Shipping Class	Cubic Feet	Ship Via	UPC Code
TRL-65-4R-BL	5303640	65 Gallon	214#	73 X 26 X 30.5	150	33.5	LTL	733029124494
TRL-65-4R-7	5303639	65 Gallon	230#	73 X 26 X 30.5	150	33.5	LTL	733029124487





# 200 GALLON TRAILER SPRAYER



## BRIGGS & STRATTON ENGINE

- 127cc Gas Engine
- XR550 Engine
- 5.50 ft-lb Gross Torque



## TRAILER HITCH

- Height Adjustable
- Fold Away Tongue Stand



## EASY ACCESS TO COMPONENTS

- Direct Drive Hypro 4 Roller Pump
- 7.2 GPM Max Flow
- 150 PSI Max Pressure
- Pressure Regulator
- Anti Vortex Suction Bulkhead
- 0-400 PSI Liquid Filled Pressure Gauge



## HEAVY DUTY SPRAY NOZZLE

- Rubber Grip
- Adjustable Spray Pattern



## HEAVY DUTY WHEELS

- 23" Diameter x 10.5" Wide Pneumatic Turf Tires
- 12" 5 Bolt Rims



## MANUAL HOSE REEL

- 100 Feet
- 600 PSI 1/2" PVC Hose

**MAXIMUM TOW SPEED 10 MPH**

## FT-200-4R

Sprayer Weight	Water Weight	Sprayer W/Water Weight
550 lbs	1670 lbs	2220 lbs

Model #	Code #	Tank Size	Shipping Weight	Carton Size	Shipping Class	Cubic Feet	Ship Via	UPC Code
FT-200-4R	5303634	200 Gallon	550#	84 X 60 X 54	150	157.5	LTL	733029123909



# 200 GALLON PASTURE SPRAYER



### BRIGGS & STRATTON ENGINE

- 127cc Gas Engine
- Hypro 4 Roller Cast Iron Pump
- The Long-Life OHV Design Runs Cool And Clear To Deliver Exceptional Power And Fuel Economy
- The Forged Crankshaft And Dura-Bore Cast Iron Cylinder Sleeve Withstand Wear And Tear For A Long Engine Life



### TRAILER HITCH

- Height Adjustable
- Fold Away Tongue Stand



### PRESSURE GAUGE / RELIEF VALVE

- 2" Pressure Gauge 0-200 PSI
- TeeJet Pressure Regulator
- TeeJet Directo Valves For Left And Right Boom Control



### 22" HIGH PRESSURE SPRAY WAND

- Ergonomic Design Lends To Less Fatigue
- Up To 38 Ft Horizontal & 27 Ft Vertical Spray
- Adjustable Spray Pattern



### 25 FEET OF 3/8 INCH HOSE

- Chemical Resistant Rubber Hose
- Easy To Wrap For Storage
- Less Prone To Kinking

## 200 GALLON TANK

### SUPERIOR TANK STRENGTH

- High Density Polyethylene Tank with UV Stabilizer
- Delivers Years of Dependable Use
- 10" Tethered Lid



### HEAVY DUTY WHEELS

- 23" Diameter x 10.5" Wide Pneumatic Turf Tires
- 12" 5 Bolt Rims



### 2-NOZZLE BROADCAST

- Stainless Steel Fittings With 32' Coverage At 4.8 GPM
- Hypro XT024 Boom X Tender Spray Nozzles
- Toolless Nozzle Height Adjustment

## MAXIMUM TOW SPEED 10 MPH

# ATVTS-200-4R-BL

Sprayer Weight	Water Weight	Sprayer W/Water Weight
550 lbs	1670 lbs	2220 lbs

Model #	Code #	Tank Size	Shipping Weight	Carton Size	Shipping Class	Cubic Feet	Ship Via	UPC Code
ATVTS-200-4R-BL	5303223	200 Gallon	550#	84 X 60 X 54	150	157.5	LTL	733029122339



# 15 GALLON 2-NOZZLE VALUE ATV SPRAYER



**HIGHFLO**  
HIGH PERFORMANCE

### BEST IN CLASS PUMP

- 1.2 GPM High Performance 12 Volt Pump
- Maximum Pressure Of 60 PSI
- Pressure Switch Turns Pump On/Off As Needed
- Self Priming
- Can Run Dry Without Damage
- Chemical Resistant Components
- Fan Cooled To Promote Longevity & Efficiency



### FUSE PROTECTED 8 FT LEAD WIRE

- Industry Leader In Safety
- Protects Vehicle Wiring
- Clips And On / Off Switch Included



### Y MANIFOLD

- Lever Ball Valves Allow Flow & Pressure Control
- Garden Hose Threading Enables Fast Configuration



### LEVER GRIP SPRAY WAND

- Up To 25 Feet Horizontal Spray
- Up To 15 Feet Vertical Spray
- Adjustable Spray Pattern



### 15 FEET OF 3/8 INCH HOSE

- Chemical Resistant Rubber Hose
- Remains Flexible
- Less Prone To Kinking

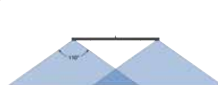

### 2-NOZZLE RIGID STEEL BOOM

- 2-Nozzle Boom Delivers 7 Feet Of Spray Coverage

## 15-2N-ATV-GS

Sprayer Model	Sprayer Weight	Water Weight	Sprayer W/Water Weight
15-2N-ATV-GS	26 lbs	125 lbs	151 lbs

Model #	Code #	Tank Size	Shipping Weight	Carton Size	Shipping Class	Cubic Feet	Ship Via	UPC Code
15-2N-ATV-GS	5303197	15 Gallon	26#	40 X 15.75 X 15	150	5.5	GROUND	733029122049



# 25 GALLON 3-NOZZLE ATV SPRAYER



**HIGHFLO**  
HIGH PERFORMANCE

### BEST IN CLASS PUMP

- 2.4 GPM High Performance 12 Volt Pump
- Maximum Pressure Of 60 PSI
- Pressure Switch Turns Pump On & Off
- Self Priming - Can Run Dry Without Damage
- Fuse Protected
- Chemical Resistant Components
- Fan Cooled To Promote Longevity & Efficiency



### FUSE PROTECTED 8 FT LEAD WIRE

- Helps Protect Your Vehicle Wiring
- Alligator Clips & On/Off Switch Included



### MANIFOLD W/PRESSURE GAUGE

- Lever Ball Valves Allow Flow & Pressure Control
- Easily Monitor Pressure With Highly Visible Gauge
- Quick Connect Fittings Enables Fast Configuration



### LEVER GRIP SPRAY WAND

- Up To 30 Feet Horizontal Spray
- Up To 16 Feet Vertical Spray
- Adjustable Spray Pattern



### 15 FEET OF 3/8 INCH HOSE

- Chemical Resistant Rubber Hose
- Remains Flexible
- Less Prone To Kinking



### PREMIUM SPRAY TIPS

- TeeJet Turbo Floodjet TF-VP3
- Reduces Chemical Drift
- Includes Check Valve Strainer



### 3-NOZZLE FOLDING STEEL BOOM

- Delivers 10 Feet of Spray Coverage
- 40 Inch Nozzle Spacing
- 82" Folding Steel Boom

## 25-3N-ATV-GS

Sprayer Weight	Water Weight	Sprayer W/Water Weight
30 lbs	209 lbs	239 lbs

Model #	Code #	Tank Size	Shipping Weight	Carton Size	Shipping Class	Cubic Feet	Ship Via	UPC Code
25-3N-ATV-GS	5303648	25 Gallon	30#	40 X 15.75 X 21.25	150	7.7	GROUND	733029124814



# 15 & 20 GALLON 2-NOZZLE ATV SPRAYERS



**HIGHFLO**  
HIGH PERFORMANCE

### BEST IN CLASS PUMP

- 2.4 GPM High Performance 12 Volt Pump
- Maximum Pressure Of 60 PSI
- Pressure Switch Turns Pump On & Off
- Self Priming
- Can Run Dry Without Damage
- Chemical Resistant Components
- Fan Cooled To Promote Longevity & Efficiency



### MANIFOLD W/PRESSURE GAUGE

- Lever Ball Valves Allow Flow & Pressure Control
- Easily Monitor Pressure With Highly Visible Gauge
- Quick Connect Fittings Enables Fast Configuration



### FUSE PROTECTED 8 FT LEAD WIRE

- Helps Protect Your Vehicle Wiring
- Alligator Clips & On/Off Switch Included



### QUICK RELEASE BOOM CLAMPS

- Quickly And Easily Install Or Remove Boom
- Securely Clamps Boom Into Place



### LEVER GRIP SPRAY WAND

- Up To 30 Feet Horizontal Spray
- Up To 16 Feet Vertical Spray
- Adjustable Spray Pattern



### 15 FEET OF 3/8 INCH HOSE

- Chemical Resistant Rubber Hose
- Easy To Wrap For Storage
- Less Prone To Kinking



### PREMIUM SPRAY TIPS

- Premium Wide Angle Tips
- Reduces Chemical Drift
- Includes Anti-Drip Strainer

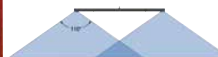

### 2-NOZZLE RIGID STEEL BOOM

- 2-Nozzle Boom Delivers 7 Feet Of Spray Coverage
- Solid Steel Boom

## ATV-15-2-QR & ATV-20-2-QR

Sprayer Model	Sprayer Weight	Water Weight	Sprayer W/ Water Weight
ATV-15-2-QR	25 lbs	167 lbs	192 lbs
ATV-20-2-QR	27 lbs	167 lbs	194 lbs

Model #	Code #	Tank Size	Shipping Weight	Carton Size	Shipping Class	Cubic Feet	Ship Via	UPC Code
ATV-15-2-QR	5302318	15 Gallon	26#	40 x 19 x 16	150	7.1	GROUND	733029110022
ATV-20-2QR	5302319	20 Gallon	27#	40 x 19 x 16	150	7.1	GROUND	733029110039



# 25 GALLON 7-NOZZLE ATV SPRAYER



**HIGHFLO**  
HIGH PERFORMANCE

### BEST IN CLASS PUMP

- 2.4 GPM High Performance 12 Volt Pump
- Maximum Pressure Of 60 PSI
- Pressure Switch Turns Pump On & Off
- Self Priming
- Can Run Dry Without Damage
- Chemical Resistant Components
- Fan Cooled To Promote Longevity & Efficiency



### MANIFOLD W/PRESSURE GAUGE

- Lever Ball Valves Allow Flow & Pressure Control
- Easily Monitor Pressure With Highly Visible Gauge
- Quick Connect Fittings Enables Fast Configuration



### FUSE PROTECTED 8 FT LEAD WIRE

- Helps Protect Your Vehicle Wiring
- Alligator Clips & On/Off Switch Included



### QUICK RELEASE BOOM CLAMPS

- Quickly And Easily Install Or Remove Boom
- Securely Clamps Boom Into Place



### LEVER GRIP SPRAY WAND

- Up To 30 Feet Horizontal Spray
- Up To 16 Feet Vertical Spray
- Adjustable Spray Pattern



### 15 FEET OF 3/8 INCH HOSE

- Chemical Resistant Rubber Hose
- Easy To Wrap For Storage
- Less Prone To Kinking



### PREMIUM SPRAY TIPS

- Premium Air Induction Tips
- Reduces Chemical Drift
- Includes Anti-Drip Strainer



### 7-NOZZLE FOLDING STEEL BOOM

- 7-Nozzle Boom Delivers 12 Feet Of Spray Coverage
- Folding Steel Boom

## ATV-25-700-QR

Sprayer Weight	Water Weight	Sprayer W/Water Weight
50 lbs	209 lbs	268 lbs

Model #	Code #	Tank Size	Shipping Weight	Carton Size	Shipping Class	Cubic Feet	Ship Via	UPC Code
ATV-25-700-QR	5302320	25 Gallon	56#	56 x 20 x 21	150	13.7	GROUND	733029110046



# 25 GALLON 7-NOZZLE DELUXE ATV SPRAYER



**HIGHFLO**  
HIGH PERFORMANCE

### BEST IN CLASS PUMP

- 4.5 GPM High Performance 12 Volt Pump
- Maximum Pressure Of 60 PSI
- Pressure Switch Turns Pump On & Off
- Self Priming
- Can Run Dry Without Damage
- Chemical Resistant Components
- Fan Cooled To Promote Longevity & Efficiency



### MANIFOLD W/PRESSURE GAUGE

- Lever Ball Valves Allow Flow & Pressure Control
- Easily Monitor Pressure With Highly Visible Gauge
- Quick Connect Fittings Enables Fast Configuration



### FUSE PROTECTED 8 FT LEAD WIRE

- Helps Protect Your Vehicle Wiring
- Alligator Clips & On/Off Switch Included



### QUICK RELEASE BOOM CLAMPS

- Quickly And Easily Install Or Remove Boom
- Securely Clamps Boom Into Place



### DELUXE PISTOL GRIP SPRAY WAND

- Up To 40 Feet Horizontal Spray
- Up To 28 Feet Vertical Spray
- Adjustable Spray Pattern



### 15 FEET OF 3/8 INCH HOSE

- Chemical Resistant Rubber Hose
- Easy To Wrap For Storage
- Less Prone To Kinking



### PREMIUM SPRAY TIPS

- Premium Air Induction Tips
- Reduces Chemical Drift
- Includes ChemSaver Drip-Free Shut Off



### 7-NOZZLE FOLDING STEEL BOOM

- 7-Nozzle Boom Delivers 12 Feet Of Spray Coverage
- Shielded Folding Steel Boom

## ATV-25-71-QR

Sprayer Weight	Water Weight	Sprayer W/Water Weight
64 lbs	209 lbs	273 lbs

Model #	Code #	Tank Size	Shipping Weight	Carton Size	Shipping Class	Cubic Feet	Ship Via	UPC Code
ATV-25-71-QR	5302321	25 Gallon	65#	56 x 20 x 21	150	13.7	GROUND	733029110053



# 25 GALLON 2-NOZZLE BROADCAST ATV SPRAYER



**HIGHFLO**  
HIGH PERFORMANCE

### BEST IN CLASS PUMP

- 4.5 GPM High Performance 12 Volt Pump
- Maximum Pressure Of 60 PSI
- Pressure Switch Turns Pump On & Off
- Self Priming
- Can Run Dry Without Damage
- Chemical Resistant Components
- Fan Cooled To Promote Longevity & Efficiency



### FUSE PROTECTED 8 FT LEAD WIRE

- Helps Protect Your Vehicle Wiring
- Alligator Clips & On/Off Switch Included



### PREMIUM SPRAY TIPS

- FIMCO Exclusive Long Range Spray Nozzles
- Reduces Chemical Drift



### GARDEN HOSE MANIFOLD

- Allows User to Fine Tune Chemical Application
- Standard Garden Hose Fittings



### QUICK RELEASE BOOM CLAMPS

- Quickly And Easily Install Or Remove Boom
- Securely Clamps Boom Into Place



### DELUXE PISTOL GRIP SPRAY WAND

- Up To 40 Feet Horizontal Spray
- Up To 25 Feet Vertical Spray
- Adjustable Spray Pattern



### 15 FEET OF 3/8 INCH HOSE

- Chemical Resistant Rubber Hose
- Easy To Wrap For Storage
- Less Prone To Kinking



### 2-NOZZLE BROADCAST BOOM

- 2 Nozzle Spray Pattern
- Delivers 28 Feet Of Spray Coverage

## LG-25-BL-QR

Sprayer Weight	Water Weight	Sprayer W/Water Weight
31 lbs	209 lbs	240 lbs

Model #	Code #	Tank Size	Shipping Weight	Carton Size	Shipping Class	Cubic Feet	Ship Via	UPC Code
LG-25-BL-QR	5302323	25 Gallon	37#	39 x 19 x 16	150	6.9	GROUND	733029110077





# 25 GALLON 3-NOZZLE BROADCAST ATV SPRAYER



**HIGHFLO**  
HIGH PERFORMANCE

### BEST IN CLASS PUMP

- 4.5 GPM High Performance 12 Volt Pump
- Maximum Pressure Of 60 PSI
- Pressure Switch Turns Pump On & Off
- Self Priming
- Can Run Dry Without Damage
- Chemical Resistant Components
- Fan Cooled To Promote Longevity & Efficiency



### MANIFOLD W/PRESSURE GAUGE

- Lever Ball Valves Allow Flow & Pressure Control
- Easily Monitor Pressure With Highly Visible Gauge
- Quick Connect Fittings Enables Fast Configuration



### FUSE PROTECTED 8 FT LEAD WIRE

- Helps Protect Your Vehicle Wiring
- Alligator Clips & On/Off Switch Included



### QUICK RELEASE BOOM CLAMPS

- Quickly And Easily Install Or Remove Boom
- Securely Clamps Boom Into Place



### DELUXE PISTOL GRIP SPRAY WAND

- Up To 40 Feet Horizontal Spray
- Up To 28 Feet Vertical Spray
- Adjustable Spray Pattern



### 15 FEET OF 3/8 INCH HOSE

- Chemical Resistant Rubber Hose
- Easy To Wrap For Storage
- Less Prone To Kinking



### PREMIUM SPRAY TIPS

- Exclusive nozzle bodies and spray tips
- Includes on/off valves & drip free nozzles
- Each nozzle can be used independently



### 3-NOZZLE BROADCAST BOOM

- Broadcast Boom Delivers 36 Feet Of Spray Coverage
- End Nozzles Sprays 15 Feet
- Center Nozzle Sprays 6 Feet

## LG-3025-QR

Sprayer Weight	Water Weight	Sprayer W/Water Weight
31 lbs	209 lbs	240 lbs

Model #	Code #	Tank Size	Shipping Weight	Carton Size	Shipping Class	Cubic Feet	Ship Via	UPC Code
LG-3025-QR	5302322	25 Gallon	35#	39 x 19 x 16	150	6	GROUND	733029110060



# 45 GALLON 3-NOZZLE UTV SPRAYER



**HIGHFLO**  
HIGH PERFORMANCE

### BEST IN CLASS PUMP

- 2.4 GPM High Performance 12 Volt Pump
- Maximum Pressure Of 60 PSI
- Pressure Switch Turns Pump On & Off
- Self Priming - Can Run Dry Without Damage
- Fuse Protected
- Chemical Resistant Components
- Fan Cooled To Promote Longevity & Efficiency



### FUSE PROTECTED 8 FT LEAD WIRE

- Helps Protect Your Vehicle Wiring
- Alligator Clips & On/Off Switch Included



### MANIFOLD W/PRESSURE GAUGE

- Lever Ball Valves Allow Flow & Pressure Control
- Easily Monitor Pressure With Highly Visible Gauge
- Quick Connect Fittings Enables Fast Configuration



### LEVER GRIP SPRAY WAND

- Up To 30 Feet Horizontal Spray
- Up To 16 Feet Vertical Spray
- Adjustable Spray Pattern



### 15 FEET OF 3/8 INCH HOSE

- Chemical Resistant Rubber Hose
- Remains Flexible
- Less Prone To Kinking



### PREMIUM SPRAY TIPS

- TeeJet AIXR11002 Air Induction XR Flat Spray Tips
- Reduces Chemical Drift
- Includes Check Valve Strainer



### 3-NOZZLE FOLDING STEEL BOOM

- Delivers 7.5 Feet of Spray Coverage
- 30 Inch Nozzle Spacing
- 62" Folding Steel Boom
- Boom Mounts To Standard 2" Receiver

## 45-3N-UTV-GS

Sprayer Weight	Water Weight	Sprayer W/Water Weight
45 lbs	375 lbs	420 lbs

Model #	Code #	Tank Size	Shipping Weight	Carton Size	Shipping Class	Cubic Feet	Ship Via	UPC Code
45-3N-UTV-GS	5303650	45 Gallon	45#	37.5 X 23.25 X 21.5	150	10.8	GROUND	733029124791



# 65 GALLON 5-NOZZLE UTILITY VEHICLE SPRAYER



**SPRAYER  
1 YEAR  
WARRANTY  
PUMP  
2 YEAR**



**HIGHFLO**  
HIGH PERFORMANCE

### BEST IN CLASS PUMP

- 2.4 GPM High Performance 12 Volt Pump
- Maximum Pressure Of 60 PSI
- Pressure Switch Turns Pump On & Off
- Self Priming - Can Run Dry Without Damage
- Fuse Protected
- Chemical Resistant Components
- Fan Cooled To Promote Longevity & Efficiency



### FUSE PROTECTED 8 FT LEAD WIRE

- Helps Protect Your Vehicle Wiring
- Alligator Clips & On/Off Switch Included



### MANIFOLD W/PRESSURE GAUGE

- Lever Ball Valves Allow Flow & Pressure Control
- Easily Monitor Pressure With Highly Visible Gauge
- Quick Connect Fittings Enables Fast Configuration



### LEVER GRIP SPRAY WAND

- Up To 30 Feet Horizontal Spray
- Up To 20 Feet Vertical Spray
- Adjustable Spray Pattern



### 15 FEET OF 3/8 INCH HOSE

- Chemical Resistant Rubber Hose
- Remains Flexible
- Less Prone To Kinking



### PREMIUM SPRAY TIPS

- TeeJet AI XR11002 Air Induction XR Flat Spray Tips
- Reduces Chemical Drift
- Includes Check Valve Strainer



### 5-NOZZLE FOLDING STEEL BOOM

- Delivers 12.5 Feet of Spray Coverage
- 30 Inch Nozzle Spacing
- 122" Folding Steel Boom
- Boom Mounts To Standard 2" Receiver

## 65-5N-UTV-GS

Sprayer Weight	Water Weight	Sprayer W/Water Weight
56 lbs	542 lbs	598 lbs

Model #	Code #	Tank Size	Shipping Weight	Carton Size	Shipping Class	Cubic Feet	Ship Via	UPC Code
65-5N-UTV-GS	5303651	65 Gallon	56#	44.25 X 25.25 X 23.5	150	15.2	GROUND	733029124807



# 45 GALLON UTILITY VEHICLE SPRAYERS



7-Nozzle Boom



**HIGHFLO**  
HIGH PERFORMANCE

### BEST IN CLASS PUMP

- 4.5 GPM High Performance 12 Volt Pump
- Maximum Pressure Of 60 PSI
- Pressure Switch Turns Pump On & Off
- Self Priming
- Can Run Dry Without Damage
- Chemical Resistant Components
- Fan Cooled To Promote Longevity & Efficiency



### DELUXE PISTOL GRIP SPRAY WAND

- Up To 40 Feet Horizontal Spray
- Up To 28 Feet Vertical Spray
- Adjustable Spray Pattern



### 25 FEET OF 3/8 INCH HOSE

- Chemical Resistant Rubber Hose
- Easy To Wrap For Storage
- Less Prone To Kinking



### MANIFOLD W/PRESSURE GAUGE

- Lever Ball Valves Allow Flow & Pressure Control
- Easily Monitor Pressure With Highly Visible Gauge
- Quick Connect Fittings Enables Fast Configuration



### FUSE PROTECTED 8 FT LEAD WIRE

- Helps Protect Your Vehicle Wiring
- Alligator Clips & On/Off Switch Included



### FIMCO EXCLUSIVE MEASURING LID

- Accurately measure and pour chemicals
- 32 oz measuring cup is attached to tank lid
- Garden hose port secures hose for easy filling

## AVAILABLE BOOM OPTIONS

### 3-NOZZLE BROADCAST

- 36 Foot Spray Coverage
- Each Nozzle Sprays Independently

### 7-NOZZLE BOOM

- 12 Feet Spray Coverage
- Folding Steel Boom



## AVAILABLE ACCESSORY

### HEAVY DUTY HOSE REEL

- 50 Feet Of 3/8 Inch Hose

## UTV-45-7 & UTV-45-BL

Product	Tank Size	Dry Sprayer Weight Without Spray Boom	Dry Sprayer Weight With Spray Boom	Total Sprayer Weight When Filled with Water
UTV-45-7	36" x 30"	53 lbs	83 lbs	465 lbs
UTV-45-BL	36" x 30"	53 lbs	66 lbs	450 lbs

Model #	Code #	Tank Size	Shipping Weight	Carton Size	Shipping Class	Cubic Feet	Ship Via	UPC Code
UTV-45-7	5302864	45 Gallon	85#	46 x 31 x 19	150	14	LTL	733029114839
UTV-45-BL	5302865	45 Gallon	68#	37 x 31 x 18	150	14	LTL	733029114822
UTV-HR-50	5302886	NA	33#	34 x 16 x 14	85	4.5	GROUND	733029115003



# 65 GALLON UTILITY VEHICLE SPRAYERS



3-Nozzle Boomless



**HIGHFLO**  
HIGH PERFORMANCE

### BEST IN CLASS PUMP

- 4.5 GPM High Performance 12 Volt Pump
- Maximum Pressure Of 60 PSI
- Pressure Switch Turns Pump On & Off
- Self Priming
- Can Run Dry Without Damage
- Chemical Resistant Components
- Fan Cooled To Promote Longevity & Efficiency



### DELUXE PISTOL GRIP SPRAY WAND

- Up To 40 Feet Horizontal Spray
- Up To 28 Feet Vertical Spray
- Adjustable Spray Pattern



### 25 FEET OF 3/8 INCH HOSE

- Chemical Resistant Rubber Hose
- Easy To Wrap For Storage
- Less Prone To Kinking



### MANIFOLD W/PRESSURE GAUGE

- Lever Ball Valves Allow Flow & Pressure Control
- Easily Monitor Pressure With Highly Visible Gauge
- Quick Connect Fittings Enables Fast Configuration



### FUSE PROTECTED 8 FT LEAD WIRE

- Helps Protect Your Vehicle Wiring
- Alligator Clips & On/Off Switch Included



### FIMCO EXCLUSIVE MEASURING LID

- Accurately measure and pour chemicals
- 32 oz measuring cup is attached to tank lid
- Garden hose port secures hose for easy filling

## AVAILABLE BOOM OPTIONS

### 3-NOZZLE BROADCAST

- 36 Foot Spray Coverage
- Each Nozzle Sprays Independently

### 7-NOZZLE BOOM

- 12 Feet Spray Coverage
- Folding Steel Boom



## AVAILABLE ACCESSORY

### HEAVY DUTY HOSE REEL

- 50 Feet Of 3/8 Inch Hose

## UTV-65-7 & UTV-65-BL

Product	Tank Size	Dry Sprayer Weight Without Spray Boom	Dry Sprayer Weight With Spray Boom	Total Sprayer Weight When Filled with Water
UTV-65-7	47" x 34.5"	58 lbs	87 lbs	640 lbs
UTV-65-BL	47" x 34.5"	58 lbs	72 lbs	625 lbs

Model #	Code #	Tank Size	Shipping Weight	Carton Size	Shipping Class	Cubic Feet	Ship Via	UPC Code
UTV-65-7	5302830	65 Gallon	97#	48 x 36 x 19	150	18	LTL	733029114433
UTV-65-BL	5302843	65 Gallon	85#	48 x 36 x 19	150	18	LTL	733029114327
UTV-HR-50	5302886	NA	33#	34 x 16 x 14	85	4.5	GROUND	733029115003



# 30 GALLON 3-NOZZLE 3 POINT SPRAYER



**HIGHFLO**  
HIGH PERFORMANCE

### BEST IN CLASS PUMP

- 2.4 GPM High Performance 12 Volt Pump
- Maximum Pressure Of 60 PSI
- Pressure Switch Turns Pump On & Off
- Self Priming - Can Run Dry Without Damage
- Fuse Protected
- Chemical Resistant Components
- Fan Cooled To Promote Longevity & Efficiency



### LEVER GRIP SPRAY WAND

- Up To 30 Feet Horizontal Spray
- Up To 16 Feet Vertical Spray
- Adjustable Spray Pattern



### 15 FEET OF 3/8 INCH HOSE

- Chemical Resistant Rubber Hose
- Remains Flexible
- Less Prone To Kinking



### FUSE PROTECTED 8 FT LEAD WIRE

- Helps Protect Your Vehicle Wiring
- Alligator Clips & On/Off Switch Included



### PREMIUM SPRAY TIPS

- TeeJet AIXR11002 Air Induction XR Flat Spray Tips
- Reduces Chemical Drift
- Includes Check Valve Strainer



### MANIFOLD W/PRESSURE GAUGE

- Lever Ball Valves Allow Flow & Pressure Control
- Easily Monitor Pressure With Highly Visible Gauge
- Quick Connect Fittings Enables Fast Configuration



### 3-NOZZLE FOLDING STEEL BOOM

- Delivers 7.5 Feet of Spray Coverage
- 30 Inch Nozzle Spacing
- 62" Folding Steel Boom



### 3 POINT HITCH

- Category 1
- Steel Construction

## 30-3N-3PT-GS

Sprayer Weight	Water Weight	Sprayer W/Water Weight
60 lbs	250 lbs	310 lbs

Model #	Code #	Tank Size	Shipping Weight	Carton Size	Shipping Class	Cubic Feet	Ship Via	UPC Code
30-3N-3PT-GS	5303678	30 Gallon	60#	37.5 X 23.25 X 21.5	150	10.8	GROUND	733029124951



# 45 GALLON 4-NOZZLE 3 POINT SPRAYER

**SPRAYER  
1 YEAR  
WARRANTY  
PUMP  
2 YEAR**



**HIGHFLO**  
HIGH PERFORMANCE

### BEST IN CLASS PUMP

- 2.4 GPM High Performance 12 Volt Pump
- Maximum Pressure Of 60 PSI
- Pressure Switch Turns Pump On & Off
- Self Priming
- Can Run Dry Without Damage
- Chemical Resistant Components
- Fan Cooled To Promote Longevity & Efficiency



### MANIFOLD W/PRESSURE GAUGE

- Lever Ball Valves Allow Flow & Pressure Control
- Easily Monitor Pressure With Highly Visible Gauge
- Quick Connect Fittings Enables Fast Configuration



### FUSE PROTECTED 8 FT LEAD WIRE

- Helps Protect Your Vehicle Wiring
- Alligator Clips & On/Off Switch Included



### DELUXE PISTOL GRIP SPRAY WAND

- Up To 40 Feet Horizontal Spray
- Up To 25 Feet Vertical Spray
- Adjustable Spray Pattern



### 25 FEET OF 3/8 INCH HOSE

- Chemical Resistant Rubber Hose
- Easy To Wrap For Storage
- Less Prone To Kinking



### PREMIUM SPRAY TIPS

- Premium Air Induction Tips
- Reduces Chemical Drift
- Includes Anti-Drip Strainer



### 4-NOZZLE FOLDING STEEL BOOM

- 4-Nozzle Boom Delivers 10 Feet Of Spray Coverage
- Folding Steel Boom



### 3 POINT CARRIER FRAME

- Provides Strength And Support To The Tank
- Connects To The 3-Point Hitch On A Tractor
- Category 1

## 3PT-45-12V-4

Sprayer Weight	Water Weight	Sprayer W/Water Weight
97 lbs	384 lbs	481 lbs

Model #	Code #	Tank Size	Shipping Weight	Carton Size	Shipping Class	Cubic Feet	Ship Via	UPC Code
3PT-45-12V-4	5303244	45 Gallon	107#	40 x 24 x 26	150	14.5	LTL	733029122711



# 45 GALLON 3-NOZZLE BROADCAST 3 POINT SPRAYER



**HIGHFLO**  
HIGH PERFORMANCE

### BEST IN CLASS PUMP

- 4.5 GPM High Performance 12 Volt Pump
- Maximum Pressure Of 60 PSI
- Pressure Switch Turns Pump On & Off
- Self Priming
- Can Run Dry Without Damage
- Chemical Resistant Components
- Fan Cooled To Promote Longevity & Efficiency



### DELUXE PISTOL GRIP SPRAY WAND

- Up To 40 Feet Horizontal Spray
- Up To 28 Feet Vertical Spray
- Adjustable Spray Pattern



### MANIFOLD W/PRESSURE GAUGE

- Lever Ball Valves Allow Flow & Pressure Control
- Easily Monitor Pressure With Highly Visible Gauge
- Quick Connect Fittings Enables Fast Configuration



### 25 FEET OF 3/8 INCH HOSE

- Chemical Resistant Rubber Hose
- Easy To Wrap For Storage
- Less Prone To Kinking



### FUSE PROTECTED 8 FT LEAD WIRE

- Helps Protect Your Vehicle Wiring
- Alligator Clips & On/Off Switch Included



### PREMIUM SPRAY TIPS

- Exclusive nozzle bodies and spray tips
- Includes on/off valves & drip free nozzles
- Each nozzle can be used independently



### 3-NOZZLE BROADCAST BOOM

- Broadcast Boom Delivers 36 Feet Of Spray Coverage
- End Nozzles Sprays 15 Feet
- Center Nozzle Sprays 6 Feet



### 3 POINT CARRIER FRAME

- Provides Strength And Support To The Tank
- Connects To The 3-Point Hitch On A Tractor
- Category 1

## 3PT-45-12V-BL

Model #	Code #	Tank Size	Shipping Weight	Carton Size	Shipping Class	Cubic Feet	Ship Via	UPC Code
3PT-45-12V-BL	5303245	45 Gallon	116#	40 x 24 x 26	150	14.5	LTL	733029122728





# 65 GALLON 3-NOZZLE BROADCAST 3 POINT SPRAYER

**SPRAYER**  
1 YEAR  
**WARRANTY**  
**PUMP**  
2 YEAR



**HIGHFLO**  
HIGH PERFORMANCE

### BEST IN CLASS PUMP

- 4.5 GPM High Performance 12 Volt Pump
- Maximum Pressure Of 60 PSI
- Pressure Switch Turns Pump On & Off
- Self Priming - Can Run Dry Without Damage
- Fuse Protected
- Chemical Resistant Components
- Fan Cooled To Promote Longevity & Efficiency



### MANIFOLD W/PRESSURE GAUGE

- Lever Ball Valves Allow Flow & Pressure Control
- Easily Monitor Pressure With Highly Visible Gauge
- Quick Connect Fittings Enables Fast Configuration



### FUSE PROTECTED 8 FT LEAD WIRE

- Helps Protect Your Vehicle Wiring
- Alligator Clips & On/Off Switch Included



### 5 INCH TANK LID

- Lid Tethered To Tank
- Splash Prevention Flap In Lid
- Venting Reduces Tank Pressure



### DELUXE PISTOL GRIP SPRAY WAND

- Up To 40 Feet Horizontal Spray
- Up To 28 Feet Vertical Spray
- Adjustable Spray Pattern



### 25 FEET OF 3/8 INCH HOSE

- Chemical Resistant Rubber Hose
- Easy To Wrap For Storage
- Less Prone To Kinking



### PREMIUM SPRAY TIPS

- Exclusive Nozzle Bodies And Spray Tips
- Includes On/Off Valves & Drip Free Nozzles
- Each Nozzle Can Be Used Independently



### 3-NOZZLE BROADCAST BOOM

- Broadcast Boom Delivers 36 Feet Of Spray Coverage
- End Nozzles Sprays 15 Feet
- Center Nozzle Sprays 6 Feet



### 3 POINT CARRIER FRAME

- Provides Strength And Support To The Tank
- Connects To The 3-Point Hitch On A Tractor
- Category 1

## 3PT-65-12V-BL

Model #	Code #	Tank Size	Shipping Weight	Carton Size	Shipping Class	Cubic Feet	Ship Via	UPC Code
3PT-65-12V-BL	5303251	65 Gallon	121#	46 X 32.5 X 38.5	150	33.3	LTL	733029122643



# 65 GALLON 7-NOZZLE 3 POINT SPRAYER



**HIGHFLO**  
HIGH PERFORMANCE

### BEST IN CLASS PUMP

- 4.5 GPM High Performance 12 Volt Pump
- Maximum Pressure Of 60 PSI
- Pressure Switch Turns Pump On & Off
- Self Priming - Can Run Dry Without Damage
- Fuse Protected
- Chemical Resistant Components
- Fan Cooled To Promote Longevity & Efficiency



### DELUXE PISTOL GRIP SPRAY WAND

- Up To 40 Feet Horizontal Spray
- Up To 28 Feet Vertical Spray
- Adjustable Spray Pattern



### MANIFOLD W/PRESSURE GAUGE

- Lever Ball Valves Allow Flow & Pressure Control
- Easily Monitor Pressure With Highly Visible Gauge
- Quick Connect Fittings Enables Fast Configuration



### 25 FEET OF 3/8 INCH HOSE

- Chemical Resistant Rubber Hose
- Easy To Wrap For Storage
- Less Prone To Kinking



### PREMIUM SPRAY TIPS

- TeeJet AIXR11003 Air Induction XR Flat Spray Tips
- Reduces Chemical Drift
- Includes Check Valve Strainer



### FUSE PROTECTED 8 FT LEAD WIRE

- Helps Protect Your Vehicle Wiring
- Alligator Clips & On/Off Switch Included

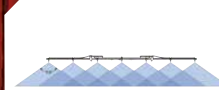

### 7-NOZZLE FOLDING BOOM

- 7-Nozzle Boom Delivers 12 Feet Of Spray Coverage
- Folding Steel Boom



### 5 INCH TANK LID

- Lid Tethered To Tank
- Splash Prevention Flap In Lid
- Venting Reduces Tank Pressure



### 3 POINT CARRIER FRAME

- Provides Strength And Support To The Tank
- Connects To The 3-Point Hitch On A Tractor
- Category 1

## 3PT-65-12V-7

Model #	Code #	Tank Size	Shipping Weight	Carton Size	Shipping Class	Cubic Feet	Ship Via	UPC Code
3PT-65-12V-7	5303250	65 Gallon	137#	46 X 32.5 X 38.5	150	33.3	LTL	733029122636



# 65 GALLON 3-NOZZLE BROADCAST 3 POINT SPRAYERS



7-Nozzle Boom



**CONSUMER**  
1 YEAR  
**WARRANTY**  
**COMMERCIAL**  
90 DAYS

## INCLUDED WITH 3PT-65-6R-7 & 3PT-65-6R-BL ONLY



### 6 ROLLER PUMP

- 9.76 GPM at 540 RPM - 18.2 GPM at 1000 RPM
- Max Pressure 300 PSI - Max Speed 1200 RPM
- Max Output 21.8 GPM



### DIE CAST QUICK COUPLER

- Multi-Speed Die Cast Quick Coupler
- Easy PTO Connection



### DELUXE PISTOL GRIP SPRAY WAND

- Up To 45 Feet Horizontal Spray
- Up To 30 Feet Vertical Spray
- Adjustable Spray Pattern



### 3 POINT CARRIER FRAME

- Provides Strength And Support To The Tank
- Connects To The 3-Point Hitch On A Tractor
- Category 1

## AVAILABLE BOOM OPTIONS

### 3-NOZZLE BROADCAST

- 36 Foot Spray Coverage
- Each Nozzle Sprays Independently

### 7-NOZZLE BOOM

- 12 Feet Spray Coverage
- Folding Steel Boom

Model #	Code #	Tank Size	Shipping Weight	Carton Size	Shipping Class	Cubic Feet	Ship Via	UPC Code
3PT-65-6R-BL	5303253	65 Gallon	135#	46 X 32.5 X 38.5	150	33.3	LTL	733029122650
3 Boomless Nozzles, Includes Pump, Coupler and Spray Wand								
3PT-65-NR-BL	5303255	65 Gallon	127#	46 X 32.5 X 38.5	150	33.3	LTL	733029122698
Includes Spray Wand, Pump and Coupler NOT Included.								
3PT-65-6R-7	5303252	65 Gallon	151#	46 X 32.5 X 38.5	150	33.3	LTL	733029122629
7-Nozzle Boom, Includes Pump, Coupler and Spray Wand								
3PT-65-NR-7	5303254	65 Gallon	143#	46 X 32.5 X 38.5	-150	33.3	LTL	733029122681
Includes Spray Wand, Pump and Coupler NOT Included.								



# 110 GALLON 3 POINT SPRAYERS



2-Nozzle Broadcast



## 110 GALLON TANK

### SUPERIOR TANK STRENGTH

- High Density Polyethylene Tank with UV Stabilizer
- Delivers Years of Dependable Use



### 6 ROLLER PUMP

- 9.76 GPM at 540 RPM - 18.2 GPM at 1000 RPM
- Max Pressure 300 PSI - Max Speed 1200 RPM
- Max Output 21.8 GPM



### 3 POINT CARRIER FRAME

- Connects To The 3-Point Hitch On A Tractor
- CAT I Direct, CAT II Direct, CAT II Quick, and CAT III Narrow Quick
- Provides Strength and Support To The Tank



### PLUMBING KIT

- TeeJet Selector Valve and Pressure Relief/Regulator
- 22" Pro Series Spray Wand w/25' of 3/8" Hose
- Plumbing Kit



### 10-NOZZLE FOLDING BOOM

- 17' Coverage With 10 Nozzles
- TeeJet AIXR Nozzle – 0.3 GPM at 40 PSI With Strainer
- Teejet ChemSaver Drip-free Shutoff Nozzle Body



### 2-NOZZLE BROADCAST ASSEMBLY

- 32' Coverage With 2 Nozzles
- Hypro Xtender Tip FC-XT020 – 2.0 GPM at 40 PSI
- Teejet ChemSaver Drip-free Shutoff Nozzle Body

Model #	Code #	Tank Size	Shipping Weight	Carton Size	Shipping Class	Cubic Feet	Ship Via	UPC Code
<b>3PT-110-6R-1025FX4</b>	5303763	110 Gallon	320#	51 x 46 x 89	150	121	LTL	733029126313
Includes: 6 Roller Cast Iron Pump, Quick Coupler And 22" Pro Series Spray Wand W/ 25' Of Hose; 10-Nozzle FX4 Boom								
<b>3PT-110-6R-2BB</b>	5303764	110 Gallon	285#	51 x 46 x 50	150	68	LTL	733029126337
Kit Includes: 6 Roller Cast Iron Pump, Quick Coupler And 22" Pro Series Spray Wand W/ 25' Of Hose; 2 Broadcast Nozzles								
<b>3PT-110-NR-1025FX4</b>	5303765	110 Gallon	310#	51 x 46 x 89	150	121	LTL	733029126344
Includes: 22" Pro Series Spray Wand W/ 25' Of Hose; 10-Nozzle FX4 Boom; Plumbing Kit Assembly; <b>Pump and Quick Coupler Not Included</b>								



# 200 GALLON 3 POINT SPRAYERS



2-Nozzle Broadcast

## 200 GALLON TANK

### SUPERIOR TANK STRENGTH

- High Density Polyethylene Tank with UV Stabilizer
- Delivers Years of Dependable Use



### 8 ROLLER PUMP

- 12 GPM at 540 RPM - 22.5 GPM at 1000 RPM
- Max Pressure 300 PSI - Max Speed 1200 RPM
- Multi-Speed Die Cast Quick Coupler



### 3 POINT CARRIER FRAME

- Connects To The 3-Point Hitch On A Tractor
- CAT I Direct, CAT II Direct, CAT II Quick, and CAT III Narrow Quick
- Provides Strength and Support To The Tank



### PLUMBING KIT

- TeeJet Selector Valve and Pressure Relief/Regulator
- 22" Pro Series Spray Wand w/25' of 3/8" Hose
- Plumbing Kit



### 12-NOZZLE FOLDING BOOM

- 20' Coverage With 12 Nozzles
- TeeJet AIXR Nozzle – 0.3 GPM at 40 PSI With Strainer
- Teejet ChemSaver Drip-free Shutoff Nozzle Body



### 2-NOZZLE BROADCAST ASSEMBLY

- 32' Coverage With 2 Nozzles
- Hypro Xtender Tip FC-XT020 – 2.0 GPM at 40 PSI
- Teejet ChemSaver Drip-free Shutoff Nozzle Body

Model #	Code #	Tank Size	Shipping Weight	Carton Size	Shipping Class	Cubic Feet	Ship Via	UPC Code
<b>3PT-200-8R-1225FX4</b>	5303767	200 Gallon	415#	51 x 46 x 89	150	121	LTL	733029126368
Includes: 8 Roller Cast Iron Pump, Quick Coupler And 22" Pro Series Spray Wand W/ 25' Of Hose; 12-Nozzle FX4 Boom								
<b>3PT-200-8R-2BB</b>	5303768	200 Gallon	375#	51 x 46 x 60	150	82	LTL	733029126375
Kit Includes: 8 Roller Cast Iron Pump, Quick Coupler And 22" Pro Series Spray Wand W/ 25' Of Hose; 2 Broadcast Nozzles								
<b>3PT-200-NR-1225FX4</b>	5303769	200 Gallon	400#	51 x 46 x 89	150	121	LTL	733029126382
Includes: 22" Pro Series Spray Wand W/ 25' Of Hose; 12-Nozzle FX4 Boom; Plumbing Kit Assembly; <b>Pump and Quick Coupler Not Included</b>								



# 300 GALLON 3 POINT SPRAYERS



2-Nozzle Broadcast

## 300 GALLON TANK

### SUPERIOR TANK STRENGTH

- High Density Polyethylene Tank with UV Stabilizer
- Delivers Years of Dependable Use



### PLUMBING KIT

- TeeJet Selector Valve and Pressure Relief/Regulator
- 22" Pro Series Spray Wand w/25' of 3/8" Hose
- Plumbing Kit



### 8 ROLLER PUMP

- 12 GPM at 540 RPM - 22.5 GPM at 1000 RPM
- Max Pressure 300 PSI - Max Speed 1200 RPM
- Multi-Speed Die Cast Quick Coupler



### 17-NOZZLE FOLDING BOOM

- 28' Coverage With 17 Nozzles
- TeeJet AIXR Nozzle – 0.3 GPM at 40 PSI With Strainer
- Teejet ChemSaver Drip-free Shutoff Nozzle Body



### 3 POINT CARRIER FRAME

- Connects To The 3-Point Hitch On A Tractor
- CAT I Direct, CAT II Direct, CAT II Quick, and CAT III Narrow Quick
- Provides Strength and Support To The Tank



### 2-NOZZLE BROADCAST ASSEMBLY

- 32' Coverage With 2 Nozzles
- Hypro Xtender Tip FC-XT020 – 2.0 GPM at 40 PSI
- Teejet ChemSaver Drip-free Shutoff Nozzle Body

Model #	Code #	Tank Size	Shipping Weight	Carton Size	Shipping Class	Cubic Feet	Ship Via	UPC Code
<b>3PT-300-8R-1725FX5</b>	5303771	300 Gallon	555#	90 x 48 x 60	150	150	LTL	733029126405
Includes: 8 Roller Cast Iron Pump, Quick Coupler And 22" Pro Series Spray Wand W/ 25' Of Hose; 17-Nozzle FX5 Boom								
<b>3PT-300-8R-2BB</b>	5303772	300 Gallon	455#	90 x 48 x 60	150	150	LTL	733029126412
Kit Includes: 8 Roller Cast Iron Pump, Quick Coupler And 22" Pro Series Spray Wand W/ 25' Of Hose; 2 Broadcast Nozzles								
<b>3PT-300-NR-1725FX5</b>	5303773	300 Gallon	540#	90 x 48 x 60	150	150	LTL	733029126429
Includes: 22" Pro Series Spray Wand W/ 25' Of Hose; 17-Nozzle FX5 Boom; Plumbing Kit Assembly; <b>Pump and Quick Coupler Not Included</b>								



# SKID MOUNTED SPRAYERS



## BRIGGS & STRATTON ENGINE

- 205cc Gas Engine
- 8 Roller Pump
- Adjustable Pressure / Pressure Gauge
- Suction Line Filter



## 8 ROLLER PUMP

- Max. Output to 22.1 GPM - Pressure to 200 PSI
- Max. Speed 800 RPM
- Temperature to 140° F



## 22" HIGH PRESSURE SPRAY WAND

- Ergonomic Design Leads To Less Fatigue
- Up To 38 Ft Horizontal & 27 Ft Vertical Spray
- Adjustable Spray Pattern
- 25' of 3/8" Hose

## 9-150

Model #	Code #	Tank Size	Shipping Weight	Carton Size	Shipping Class	Cubic Feet	Ship Via	UPC Code
9-150	5300431	150 Gallon	314#	79 x 41 x 49	150	91.9	LTL	733029001214

## SK-110-8R & 9-200

Model #	Code #	Description	Shipping Weight	Unit Weight
SK-110-8R	5301052	110 Gallon Poly Tank Skid Sprayer	279#	229
9-200	5300655	200 Gallon Poly Tank Skid Sprayer	336#	286

### OPTIONAL ACCESSORIES FOR 150 GAL SKIDS

Model #	Code #	Description	Unit Weight
BK-6	5300260	Boom Assy w/ 13 Vari-Spacing Nozzles, 21' Coverage	90#



# 150 GALLON SKID SPRAYER



## BRIGGS & STRATTON ENGINE

- 127cc Gas Engine
- XR550 Engine
- 5.5 ftlb Gross Torque



## EASY ACCESS TO COMPONENTS

- Direct Drive Hypro 4 Roller Pump
- 7.2 Gpm Max Flow
- 150 Psi Max Pressure
- Pressure Regulator
- Anti Vortex Suction Bulkhead



## HEAVY DUTY SPRAY NOZZLE

- Rubber Grip
- Adjustable Spray Pattern



## MANUAL HOSE REEL

- 100 Feet
- 600 PSI 1/2" PVC Hose

## DIMENSIONS & WEIGHTS

- 60" L x 49" W x 46" H
- 175 lb Dry Weight
- 1400 lb Wet Weight

## FS-150-4R

Sprayer Weight	Water Weight	Sprayer W/Water Weight
175 lbs	1400 lbs	1575 lbs

Model #	Code #	Tank Size	Shipping Weight	Carton Size	Shipping Class	Cubic Feet	Ship Via	UPC Code
FS-150-4R	5303066	150 Gallon	195#	60" x 50" x 52"	150	90.4	LTL	733029119421





# 200 GALLON SKID SPRAYER



### QUICK COUPLER

- Stainless Steel Construction
- Allows Quick Change Of Handguns



### HEAVY DUTY SPRAY NOZZLE

- Rubber Grip
- Adjustable Spray Pattern



### 22" HIGH PRESSURE SPRAY WAND

- Ergonomic Design Lends To Less Fatigue
- Up To 38 Ft Horizontal & 27 Ft Vertical Spray
- Adjustable Spray Pattern

Sprayer Model	Sprayer Weight	Water Weight	Sprayer W/Water Weight
LSS-235-H	396 lbs	1668 lbs	2064 lbs
LSS-240	401 lbs	1668 lbs	2069 lbs
LSS-280	396 lbs	1668 lbs	2064 lbs
LSS-280-EH	401 lbs	1668 lbs	2069 lbs
LSS-280-H	396 lbs	1668 lbs	2064 lbs

Model #	Code #	Tank Size	Shipping Weight	Carton Size	Shipping Class	Cubic Feet	Ship Via	UPC Code
LSS-240	5301259	200 Gallon	500#	79 x 41 x 49	150	91.0	LTL	733029004352
196cc Power Pro Recoil Start Engine • Three Diaphragm Pump - 580 P.S.I. - 10 G.P.M. • Hand Rewind Hose Reel • 300 Ft. of 600 P.S.I. Working Pressure PVC Hose • Tank Equipped with Agitator • Heavy Duty Pistol Grip Spray Wand • 37 Ft. Vertical Spray Height								
LSS-235-H	5301869	200 Gallon	518#	79 x 41 x 49	150	91.0	LTL	733029008787
163cc Honda Engine & Electric Hose Reel								

Model #	Code #	Tank Size	Shipping Weight	Carton Size	Shipping Class	Cubic Feet	Ship Via	UPC Code
LSS-280	5300467	200 Gallon	396#	79 x 41 x 49	150	91.0	LTL	733029001139
205cc Briggs & Stratton Recoil Start Engine • 8 Roller Pump - 0-150 P.S.I. - 7.8 G.P.M. • Hand Rewind Hose Reel 300 Ft. of 1/2" 2 Braid Rubber Hose • Tank Equipped with Agitator • Heavy Duty Pistol Grip Spray Wand								
LSS-280-H	5301865	200 Gallon	500#	79 x 41 x 49	150	91.0	LTL	733029008749
163cc Honda Engine								
LSS-280-EH	5301867	200 Gallon	518#	79 x 41 x 49	150	91.0	LTL	733029008763
163cc Honda Engine & Electric Hose Reel								



# 300 GALLON SKID SPRAYER



## HONDA ENGINE

- 163cc Gas Engine
- Recoil Start



## ELECTRIC HOSE REEL

- Electric Rewind Hose Reel
- Spool Kit 300 Feet
- 600 PSI, 1/2" PVC Hose



## EASY ACCESS TO COMPONENTS

- 3 Diaphragm Pump
- Strainer
- 3/4" Single Union Ball Valve
- Pressure Gauge
- Pressure Regulator Control



## 22" HIGH PRESSURE SPRAY WAND

- Ergonomic Design Lends To Less Fatigue
- Up To 38 Ft Horizontal & 27 Ft Vertical Spray
- Adjustable Spray Pattern



## AR30 PUMP

- 10 GMP
- 580 PSI



## ADDITIONAL TEEJET 25660 LAWN GUN

- 200 PSI
- Flow Range: 1.4 to 6.5 GPM
- 3/4" FNPT

# TSSK-300

Sprayer Weight	Water Weight	Sprayer W/Water Weight
586 lbs	2502 lbs	3088 lbs

Model #	Code #	Tank Size	Shipping Weight	Carton Size	Shipping Class	Ship Via	UPC Code
TSSK-300	5301337	300 Gallon	587#	103" x 48" x 46"	250	LTL	733029003164



# 25 GALLON PRO SERIES SPOT SPRAYER



### BEST IN CLASS PUMP

- 2.2 GPM Pro Series 12 Volt Pump
- Maximum Pressure Of 100 PSI
- Ideal For Harsh Chemicals & Oil Based Chemicals With Surfactants
- Self Priming
- Can Run Dry Without Damage



### 13" HIGH PRESSURE SPRAY WAND

- Ergonomic Design Lends To Less Fatigue
- Up To 38 Ft Horizontal & 27 Ft Vertical Spray
- Adjustable Spray Pattern



### 25 FEET OF 3/8 INCH HOSE

- Chemical Resistant Rubber Hose
- Easy To Wrap For Storage
- Less Prone To Kinking



### HEAVY DUTY 10 FT LEAD WIRE

- Helps Protect Your Vehicle Wiring
- Alligator Clips & On/Off Switch Included



### CLEAR BOWL STRAINER

- 1 Inch Clear Polycarbonate
- Strain Out Particulates
- Easily See If Strainer Is Clogged



### FIMCO EXCLUSIVE MEASURING LID

- Accurately Measure And Pour Chemicals
- 32 Oz Measuring Cup Is Attached To Tank Lid
- Garden Hose Port Secures Hose For Easy Filling

## LG-25-PRO



Sprayer Weight	Water Weight	Sprayer W/Water Weight
23 lbs	209 lbs	232 lbs

Model #	Code #	Tank Size	Shipping Weight	Carton Size	Shipping Class	Cubic Feet	Ship Via	UPC Code
LG-25-PRO	5302922	25 Gallon	24#	40 x 19 x 18	150	7.9	GROUND	733029116864



# 25 GALLON PRO SERIES 7-NOZZLE ATV SPRAYER



### BEST IN CLASS PUMP

- 4.0 GPM Pro Series 12 Volt Pump
- Maximum Pressure Of 45 PSI
- Ideal For Harsh Chemicals & Oil Based Chemicals With Surfactants
- Self Priming
- Can Run Dry Without Damage



### MANIFOLD W/PRESSURE GAUGE

- Lever Ball Valves Allow Flow & Pressure Control
- 2-1/2" Liquid Filled Gauge
- Quick Connect Fittings Enables Fast Configuration



### HEAVY DUTY 10 FT LEAD WIRE

- Helps Protect Your Vehicle Wiring
- Alligator Clips & On/Off Switch Included



### FIMCO EXCLUSIVE MEASURING LID

- Accurately Measure And Pour Chemicals
- 32 Oz Measuring Cup Is Attached To Tank Lid
- Garden Hose Port Secures Hose For Easy Filling



### CLEAR BOWL STRAINER

- 1 Inch Clear Polycarbonate
- Strain Out Particulates
- Easily See If Strainer Is Clogged



### 13" HIGH PRESSURE SPRAY WAND

- Ergonomic Design Lends To Less Fatigue
- Up To 38 Ft Horizontal & 27 Ft Vertical Spray
- Adjustable Spray Pattern



### 25 FEET OF 3/8 INCH HOSE

- Chemical Resistant Rubber Hose
- Easy To Wrap For Storage
- Less Prone To Kinking



### PREMIUM SPRAY TIPS

- Premium Air Induction Tips
- Reduces Chemical Drift
- Includes Anti-Drip Strainer



### 7-NOZZLE FOLDING BOOM

- 7-Nozzle Boom Delivers 12 Feet Of Spray Coverage
- Folding Steel Boom



### QUICK RELEASE BOOM CLAMPS

- Quickly And Easily Install Or Remove Boom
- Securely Clamps Boom Into Place

## ATV-25-700-PRO



Sprayer Weight	Water Weight	Sprayer W/Water Weight
56 lbs	209 lbs	265 lbs

Model #	Code #	Tank Size	Shipping Weight	Carton Size	Shipping Class	Cubic Feet	Ship Via	UPC Code
ATV-25-700-PRO	5302927	25 Gallon	60#	56 x 20 x 21	150	13.6	LTL	733029117434



# 25 GALLON PRO SERIES 3-NOZZLE BROADCAST SPRAYER



### BEST IN CLASS PUMP

- 4.0 GPM Pro Series 12 Volt Pump
- Maximum Pressure Of 45 PSI
- Ideal For Harsh Chemicals & Oil Based Chemicals With Surfactants
- Self Priming
- Can Run Dry Without Damage



### 13" HIGH PRESSURE SPRAY WAND

- Ergonomic Design Lends To Less Fatigue
- Up To 38 Ft Horizontal & 27 Ft Vertical Spray
- Adjustable Spray Pattern



### 25 FEET OF 3/8 INCH HOSE

- Chemical Resistant Rubber Hose
- Easy To Wrap For Storage
- Less Prone To Kinking



### MANIFOLD W/PRESSURE GAUGE

- Lever Ball Valves Allow Flow & Pressure Control
- 2-1/2" Liquid Filled Gauge
- Quick Connect Fittings Enables Fast Configuration



### PREMIUM SPRAY TIPS

- Exclusive Nozzle Bodies And Spray Tips
- Includes On/Off Valves & Drip Free Nozzles
- Each Nozzle Can Be Used Independently



### HEAVY DUTY 10 FT LEAD WIRE

- Helps Protect Your Vehicle Wiring
- Alligator Clips & On/Off Switch Included



### FIMCO EXCLUSIVE MEASURING LID

- Accurately Measure And Pour Chemicals
- 32 Oz Measuring Cup Is Attached To Tank Lid
- Garden Hose Port Secures Hose For Easy Filling



### 3-NOZZLE BROADCAST BOOM

- Broadcast Boom Delivers 36 Feet Of Spray Coverage
- End Nozzles Sprays 15 Feet
- Center Nozzle Sprays 6 Feet



### CLEAR BOWL STRAINER

- 1 Inch Clear Polycarbonate
- Strain Out Particulates
- Easily See If Strainer Is Clogged



### QUICK RELEASE BOOM CLAMPS

- Quickly And Easily Install Or Remove Boom
- Securely Clamps Boom Into Place

## LG-3025-PRO



Sprayer Weight	Water Weight	Sprayer W/Water Weight
35 lbs	209 lbs	244 lbs

Model #	Code #	Tank Size	Shipping Weight	Carton Size	Shipping Class	Cubic Feet	Ship Via	UPC Code
LG-3025-PRO	5302926	25 Gallon	36#	40 x 19 x 18	150	7.9	GROUND	733029117427



# 45 GALLON PRO SERIES 3 POINT SPRAYER



### BEST IN CLASS PUMP

- 2.2 GPM Pro Series 12 Volt Pump
- Maximum Pressure Of 100 PSI
- Ideal For Harsh Chemicals & Oil Based Chemicals With Surfactants
- Self Priming
- Can Run Dry Without Damage



### MANIFOLD W/PRESSURE GAUGE

- Lever Ball Valves Allow Flow & Pressure Control
- 2-1/2" Liquid Filled Gauge
- Quick Connect Fittings Enables Fast Configuration



### HEAVY DUTY 10 FT LEAD WIRE

- Helps Protect Your Vehicle Wiring
- Alligator Clips & On/Off Switch Included



### FIMCO EXCLUSIVE MEASURING LID

- Accurately Measure And Pour Chemicals
- 32 Oz Measuring Cup Is Attached To Tank Lid
- Garden Hose Port Secures Hose For Easy Filling



### 22" HIGH PRESSURE SPRAY WAND

- Ergonomic Design Lends To Less Fatigue
- Up To 38 Ft Horizontal & 27 Ft Vertical Spray
- Adjustable Spray Pattern



### 25 FEET OF 3/8 INCH HOSE

- Chemical Resistant Rubber Hose
- Easy To Wrap For Storage
- Less Prone To Kinking



### 4-NOZZLE FOLDING BOOM

- 4-Nozzle Boom Delivers 10 Feet Of Spray Coverage
- Folding Steel Boom
- Premium Air Induction Tips



### CLEAR BOWL STRAINER

- 1 Inch Clear Polycarbonate
- Strain Out Particulates
- Easily See If Strainer Is Clogged



### 3 POINT CARRIER FRAME

- Provides Strength And Support To The Tank
- Connects To The 3-Point Hitch On A Tractor
- Category 1

## 3PT-45-PRO-4



Sprayer Weight	Water Weight	Sprayer W/Water Weight
105 lbs	384 lbs	489 lbs

Model #	Code #	Tank Size	Shipping Weight	Carton Size	Shipping Class	Cubic Feet	Ship Via	UPC Code
3PT-45-PRO-4	5303246	45 Gallon	116#	40 x 24 x 26	125	14.5	LTL	733029122735



# 50 GALLON PRO SERIES 7-NOZZLE TRAILER SPRAYER



### BEST IN CLASS PUMP

- 4.0 GPM Pro Series 12 Volt Pump
- Maximum Pressure Of 45 PSI
- Ideal For Harsh Chemicals & Oil Based Chemicals With Surfactants
- Self Priming
- Can Run Dry Without Damage



### 22" HIGH PRESSURE SPRAY WAND

- Ergonomic Design Lends To Less Fatigue
- Up To 38 Ft Horizontal & 27 Ft Vertical Spray
- Adjustable Spray Pattern



### 25 FEET OF 3/8 INCH HOSE

- Chemical Resistant Rubber Hose
- Easy To Wrap For Storage
- Less Prone To Kinking



### MANIFOLD W/PRESSURE GAUGE

- Lever Ball Valves Allow Flow & Pressure Control
- 2-1/2" Liquid Filled Gauge
- Quick Connect Fittings Enables Fast Configuration



### HEAVY DUTY 10 FT LEAD WIRE

- Helps Protect Your Vehicle Wiring
- Alligator Clips & On/Off Switch Included



### CLEAR BOWL STRAINER

- 1 Inch Clear Polycarbonate
- Strain Out Particulates
- Easily See If Strainer Is Clogged



### FIMCO EXCLUSIVE MEASURING LID

- Accurately Measure And Pour Chemicals
- 32 Oz Measuring Cup Is Attached To Tank Lid
- Garden Hose Port Secures Hose For Easy Filling

## AVAILABLE BOOM OPTIONS

### 3-NOZZLE BROADCAST

- 36 Foot Spray Coverage
- Each Nozzle Sprays Independently

### 7-NOZZLE BOOM

- 12 Feet Spray Coverage
- Folding Steel Boom

## LG-50-TRL-PRO



Sprayer Weight	Water Weight	Sprayer W/Water Weight
180 lbs	417 lbs	597 lbs

Model #	Code #	Tank Size	Shipping Weight	Carton Size	Shipping Class	Cubic Feet	Ship Via	UPC Code
LG-50-TRL-PRO	5302928	50 Gallon	174#	56 x 41 x 29	150	36.5	LTL	733029117441
LG-50-TRL-PRO-BL	5302930	50 Gallon	170#	56 x 41 x 29	150	36.5	LTL	733029117571



# 2.2 CU FT ATV DRY MATERIAL SPREADER



45 FT



### COMPACT POLY HOPPER

- 2.2 CU FT Poly Hopper
- Holds Up To 145 Lbs Of Material



### STAINLESS STEEL RADIAL FAN

- 6 Blade Fan
- Stainless Steel



### VARIABLE SPEED CONTROL

- Control The Spread Width: 5 Feet To 45 Feet
- 20 Feet Of Wire Harness With Alligator Clips



### ADJUSTABLE SLIDE GATE

- Choose The Amount Of Dry Material To Spread
- Easy To Reach Handle



### RAIN / DUST COVER INCLUDED

- Protects Dry Materials From Adverse Elements
- Easy To Install And Securely Fitted



### MOUNTING HARDWARE

- Mounts to ATV Rack
- Heavy Duty Steel Construction



1-1/4" Hitch  
5301902



2" Hitch  
5301901

### OPTIONAL HITCHES



APPROVED FOR:

- FERTILIZER
- SEED
- BAIT
- GRANULAR
- INSECTICIDES
- FUNGICIDES
- HERBICIDES
- PELLETS
- ICE MELTING PELLETS

## ATV-DMS-12V

Model #	Code #	Capacity	Shipping Weight	Carton Size	Shipping Class	Ship Via	UPC Code
ATV-DMS-12V	5301845	2.2 cu ft	53#	29 x 21 x 22	85	GROUND	733029008633
Optional Equipment	Code #	Carton Size	Shipping Class	Ship Via	UPC Code		
1-1/4" Receiver Hitch	5301902	25 x 13 x 3	85	GROUND	733029009081		
2" Receiver Hitch	5301901	25 x 13 x 3	85	GROUND	733029009074		
Rain Cover	5058193			GROUND	733029104014		
3 Pack Rain Cover	7771916	25 x 13 x 3		GROUND	733029107442		





# 2.2 CU FT ATV / UTV DRY MATERIAL SPREADER



### COMPACT POLY HOPPER

- 2.2 CU FT Poly Hopper
- Holds Up To 145 Lbs Of Material



### STAINLESS STEEL RADIAL FAN

- 6 Blade Fan
- Stainless Steel



### 12V MOTOR W/ VARIABLE SPEED CONTROL

- Control The Spread Width: 5 Feet To 45 Feet
- 20 Feet Of Wire Harness With Alligator Clips
- On/Off Switch



### ADJUSTABLE SLIDE GATE

- Choose The Amount Of Dry Material To Spread
- Easy To Reach Handle



### RAIN / DUST COVER

- Protects Dry Materials From Adverse Elements
- Easy To Install And Securely Fitted



### 2" RECEIVER ATTACHMENT

- Fits 2" Receiver on most ATVs and UTVs
- Hitch pin included

**RECEIVER HITCH AND DUST COVER  
ARE INCLUDED WITH ATV-DMS-12V-2RC**

## ATV-DMS-12V-2RC



APPROVED FOR:

- FERTILIZER
- SEED
- BAIT
- GRANULAR
- INSECTICIDES
- FUNGICIDES
- HERBICIDES
- PELLETS
- ICE MELTING PELLETS

Model #	Code #	Capacity	Shipping Weight	Carton Size	Shipping Class	Ship Via	UPC Code
ATV-DMS-12V-2RC	5302957	2.2 cu ft	60#	29 x 21 x 22	85	GROUND	733029119216



# 2.2 CU FT TRAILER DRY MATERIAL SPREADER



### COMPACT POLY HOPPER

- 2.2 CU FT Poly Hopper
- Holds Up To 145 Lbs Of Potash



### STAINLESS STEEL RADIAL FAN

- 6 Blade Fan
- Stainless Steel



### VARIABLE SPEED CONTROL

- Control The Spread Width: 5 Feet To 45 Feet
- 20 Feet Of Wire Harness With Alligator Clips



### ADJUSTABLE SLIDE GATE

- Choose The Amount Of Dry Material To Spread
- Easy To Reach Handle



### ADJUSTABLE TRAILER HITCH

- Change The Trailer Hitch Height To Match Your Vehicle's Hitch Height

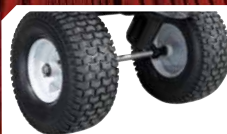

### TURF TIRES

- 15 x 6.00-6 Pneumatic Turf Tires
- 3/4 Inch Axle

## DMS-TR-12V-2.2



APPROVED FOR:

- FERTILIZER
- SEED
- BAIT
- GRANULAR
- INSECTICIDES
- FUNGICIDES
- HERBICIDES
- PELLETS
- ICE MELTING PELLETS

Model #	Code #	Hopper Size	Shipping Weight	Carton Size	Shipping Class	Cubic Feet	Ship Via	UPC Code
DMS-TR-12V-2.2	5302028	2.2 Cu Ft.	108#	29 x 20 x 26	85	8.8	LTL	733029010476



# 5.0 CU FT TRAILER DRY MATERIAL SPREADER



### LARGE POLY HOPPER

- 5.0 CU FT Poly Hopper
- Holds Up To 220 Lbs Of Potash



### STAINLESS STEEL RADIAL FAN

- 6 Blade Fan
- Stainless Steel



### VARIABLE SPEED CONTROL

- Control The Spread Width: 5 Feet To 45 Feet
- 20 Feet Of Wire Harness With Alligator Clips



### ADJUSTABLE SLIDE GATE

- Choose The Amount Of Dry Material To Spread
- Easy To Reach Handle



### ADJUSTABLE TRAILER HITCH

- Change The Trailer Hitch Height To Match Your Vehicle's Hitch Height



### TURF TIRES

- 16 x 6.50-8 Pneumatic Turf Tires
- 3/4 Inch Axle



APPROVED FOR:

- FERTILIZER
- SEED
- BAIT
- GRANULAR
- INSECTICIDES
- FUNGICIDES
- HERBICIDES
- PELLETS
- ICE MELTING PELLETS

## DMS-TR-12V-5.0

Model #	Code #	Hopper Size	Shipping Weight	Carton Size	Shipping Class	Cubic Feet	Ship Via	UPC Code
DMS-TR-12V-5.0	5302035	5.0 Cu Ft.	165#	40 x 44 x 36	85	36.7	LTL	733029010544



# 4.5 CU. FT 3 POINT DRY MATERIAL SPREADER



### LARGE POLY HOPPER

- 4.5 CU FT Poly Hopper
- Holds Up To 220 Lbs Of Potash



### STAINLESS STEEL RADIAL FAN

- 6 Blade Fan
- Stainless Steel



### VARIABLE SPEED CONTROL

- Control The Spread Width: 5 Feet To 45 Feet
- 20 Feet Of Wire Harness With Alligator Clips



### ADJUSTABLE SLIDE GATE

- Choose The Amount Of Dry Material To Spread
- Easy To Reach Handle



### CATEGORY 1 HITCH

- Easily Connects To Your Category 1 Tractor Hitch

## DMS-3PT-12V-4.5



APPROVED FOR:

- FERTILIZER
- SEED
- BAIT
- GRANULAR
- INSECTICIDES
- FUNGICIDES
- HERBICIDES
- PELLETS
- ICE MELTING PELLETS

Model #	Code #	Hopper Size	Shipping Weight	Carton Size	Shipping Class	Cubic Feet	Ship Via	UPC Code
DMS-3PT-12V-4.5	5302045	4.5 Cu Ft.	125#	40 x 26 x 30	85	18	LTL	733029010551



# POLY & STEEL LAWN ROLLERS



## STEEL LAWN ROLLER FEATURES

- 14 Gauge Steel End Cap And Drums
- Heavier Roller To Help Smooth The Yard With Less Effort

## POLY LAWN ROLLER FEATURES

- Polyethylene Drum Resist Rust And Dents
- Lightweight When Empty, For Easy Transportation And Storage
- LRP-1824 Includes a Push Handle

## COMMON FEATURES

- Tow Hitch
- Rounded End Caps Prevent Gouging And Will Not Leave Ruts
- Durable (1") Tow Hitch Tubes
- Common Hitch Pin Attachment For Easy Use With Any Vehicle
- Provides Level Surface To Combat Effects Of Freezing, Burrowing Animals, And Wheel Track Ruts
- Effective Packing Of New Seeding And Soil To Root Contact For Newly Laid Sod

## LAWN ROLLERS

Model #	Code #	Material	Roller Size	Weight With Water	Shipping Weight	Carton Size	Shipping Class	Ship Via	UPC Code
LRP-1824	5301944	Poly	18 x 24	268	42#	32 x 20 x 18	85	GROUND	733029009296
LRP-1836	5301945	Poly	18 x 36	390	51#	44 x 20 x 18	85	GROUND	733029009302
LRP-1848	5301946	Poly	18 x 48	510	63#	57 x 20 x 18	85	GROUND	733029009319
LRP-2436	5301947	Poly	24 x 36	668	76#	44 x 25 x 25	85	GROUND	733029009326
LRP-2448	5301948	Poly	24 x 48	878	92#	56 x 25 x 25	85	LTL	733029009333
LRS-2436	5301949	Steel	24 x 36	715	163#	44 x 25 x 25	85	LTL	733029009340
LRS-2448	5301950	Steel	24 x 48	934	189#	56 x 25 x 25	85	LTL	733029009357



# 42" TINE DE-THATCHER



**42"** WIDTH

### SUPERIOR STEEL CONSTRUCTION

- Folded Steel Deck
- Holds Up To 150 Lbs



### 22 TRIPLE COILED TINES

- Durable Triple Coiled Tine Rakes
- Heat Treated
- Cover And Clean More Ground

**10** MINUTE ASSEMBLY TIME

### EASY TO ASSEMBLE

- Quick Assembly Time Of 10 Minutes
- Fewer Parts Means Easier Maintenance



### TRANSPORT LEVER

- Engage Or Disengage The Tine Rakes
- Easy To Access Transport Lever
- Height Adjustable

## DTH-42

Model #	Code #	Width	Shipping Weight	Carton Size	Shipping Class	Cubic Feet	Ship Via	UPC Code
DTH-42	5301491	42 Inches	50#	50 x 13 x 11	150	4.2	GROUND	733029004581



# 42" PLUG AERATOR & 42" SPIKE AERATOR

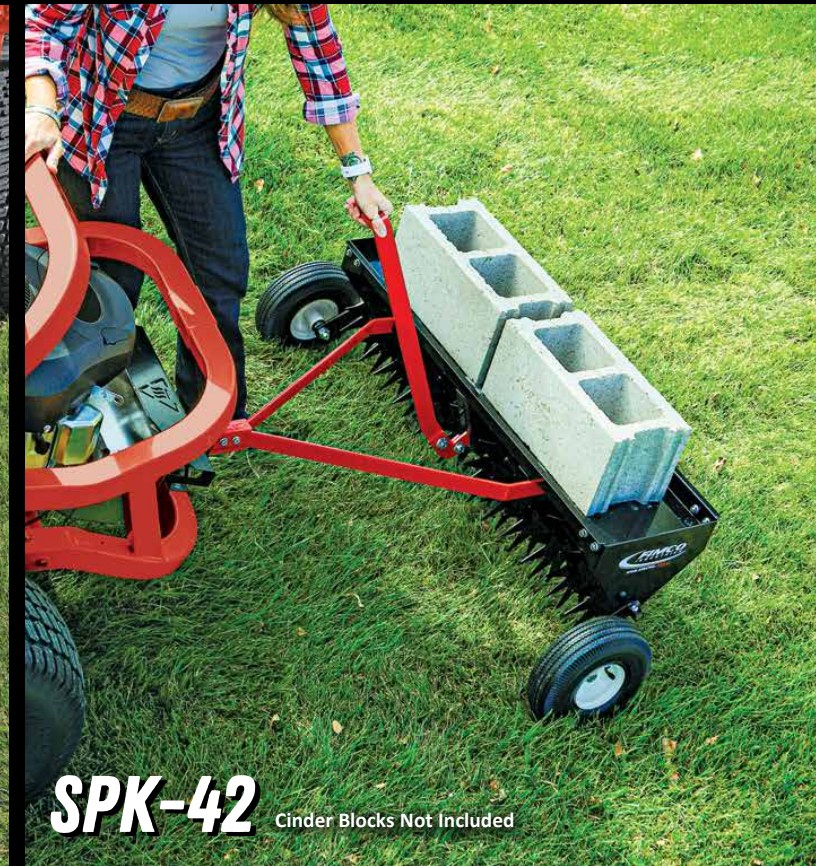
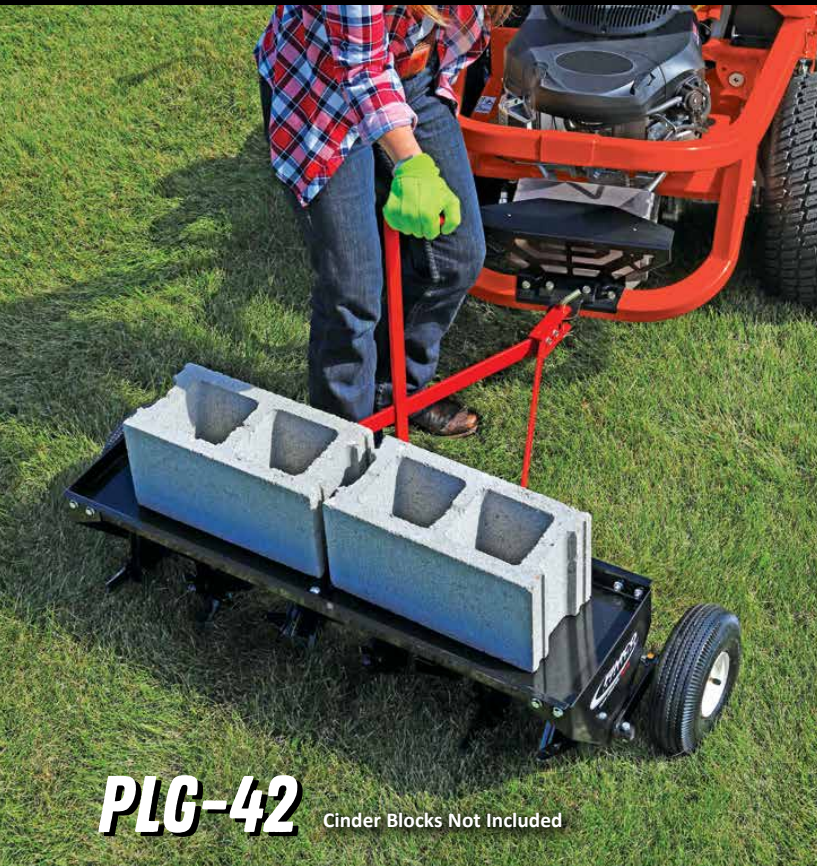

**PLG-42** Cinder Blocks Not Included

**SPK-42** Cinder Blocks Not Included

**42" WIDTH** **SUPERIOR STEEL CONSTRUCTION**

- 14 Gauge Folded Steel Deck
- Holds Up To 175 Lbs

**42" WIDTH** **SUPERIOR STEEL CONSTRUCTION**

- 14 Gauge Folded Steel Deck
- Holds Up To 175 Lbs

**24 PLUGGING POINTS**

- Penetration Depth: Up To 3 Inches
- Bushings For Smooth Plugging
- Self Cleaning

**144 SPIKING TIPS**

- Penetration Depth: Up To 2.5 Inches
- Tines: 12 10 Inch Spike Wheels

**TRANSPORT LEVER**

- Engage Or Disengage The Tine Rakes
- Easy To Access Transport Lever
- Height Adjustable

**TRANSPORT LEVER**

- Engage Or Disengage The Tine Rakes
- Easy To Access Transport Lever
- Height Adjustable

**10 MINUTE ASSEMBLY TIME** **EASY TO ASSEMBLE**

- Quick Assembly Time Of 10 Minutes
- Fewer Parts Means Easier Maintenance

**10 MINUTE ASSEMBLY TIME** **EASY TO ASSEMBLE**

- Quick Assembly Time Of 10 Minutes
- Fewer Parts Means Easier Maintenance

## PLG-42 & SPK-42

Model #	Code #	Width	Shipping Weight	Carton Size	Shipping Class	Cubic Feet	Ship Via	UPC Code
PLG-42	5301530	42 Inches	85#	51 x 18 x 14	150	7.5	GROUND	733029005182
SPK-42	5301531	42 Inches	85#	51 x 18 x 14	150	7.5	GROUND	733029005199



# 10 CU FT POLY CARTS



Shown With Push/Pull Handle Model #: TC-10-P.  
Other Models Do Not Include Push/Pull Handle.

**10** CU FT

### DURABLE POLY CONSTRUCTION

- Strong One Piece Poly Bed Design



### EASY DUMP RELEASE

- Simple Lever Releases Cart Load

**600** LBS MAX

### WEIGHT CAPACITY

- Fully Assembled Welded Pedestal & Under Carriage Frame



### MOLDED-IN FEATURES

- Easily Add Dividers To Separate Sections



### TURF TIRES

- 8 x 4.8/400 Pneumatic Turf Tires
- Metal Hub
- Maximum Speed 4 MPH

## TC-10-P, TC-10P-EC, & TC-10P-EC-B

Model #	Code #	Box Size	Shipping Weight	Carton Size	Shipping Class	Cubic Feet	Ship Via	UPC Code
TC-10-P	5301461	10 Cu. Ft.	75#	49 x 36 x 14	85	14.3	GROUND	733029003614
TC-10P-EC**	5301841	10 Cu. Ft.	575 Pallet	-	85	-	LTL	733029008589
TC-10P-EC-B	5302051	10 Cu. Ft.	75	49 x 36 x 14	85	14.5	GROUND	733029010605

\*\*Available only in bulk packaging of 8 carts





# 15 CU FT ATV POLY CARTS



## 15 CU FT

### DURABLE POLY CONSTRUCTION

- Strong One Piece Poly Bed Design
- Bed Dimensions: 48" L x 40" W x 14" H

## 700 LBS MAX

### WEIGHT CAPACITY

- Fully Assembled Welded Pedestal & Under Carriage Frame



### TURF TIRES

- 16 x 6.5-8 Turf Tires With Metal Hub
- 3/4" Solid Steel Axle
- Maximum Speed 4 MPH



### EASY STEP DUMP RELEASE

- Simple Step Lever Releases Cart Load



### MOLDED-IN FEATURES

- Easily Add Dividers To Separate Sections

## TC-15-HP

Model #	Code #	Box Size	Shipping Weight	Carton Size	Shipping Class	Cubic Feet	Ship Via	UPC Code
TC-15-HP	5302027	15 Cu Ft.	85#	48 x 40 x 14	85	16.5	LTL	733029010469



# 10 CU FT STEEL CART & 17 CU FT STEEL CART



**TC-10-18**



**TC-17**

**10 CU FT**

**SOLID STEEL CONSTRUCTION**

- Gauge Of Steel: 18 Gauge Body; 16 Gauge Tailgate
- Removable Tailgate With Slotted Base

**17 CU FT**

**SOLID STEEL CONSTRUCTION**

- Gauge Of Steel: 16 Gauge Body; 16 Gauge Tailgate
- Removable Tailgate With Slotted Base

**750 LBS MAX**

**WEIGHT CAPACITY**

- Fully Assembled Welded Pedestal & Under Carriage Frame

**1500 LBS MAX**

**WEIGHT CAPACITY**

- Fully Assembled Welded Pedestal & Under Carriage Frame



**EASY DUMP RELEASE**

- Simple Lever Releases Cart Load



**EASY DUMP RELEASE**

- Simple Lever Releases Cart Load



**TURF TIRES**

- 8 x 4.8/400 Pneumatic Turf Tires
- Metal Hub
- Maximum Speed 4 MPH



**TURF TIRES**

- 16 x 6.5-8 Turf Tires With Metal Hub
- 3/4" Solid Steel Axle
- Maximum Speed 4 MPH

## TC-10-18 & TC-17

Model #	Code #	Box Size	Shipping Weight	Carton Size	Shipping Class	Cubic Feet	Ship Via	UPC Code
TC-10-18	5301546	10 Cu. Ft.	108#	44 x 34 x 14	85	12.2	GROUND	733029005243
TC-17	5301397	17 Cu. Ft.	200#	61 x 39 x 17	85	23.4	LTL	733029003331



# 4 WHEEL STEERABLE 17 CU FT STEEL CART



**17** CU FT

### DURABLE STEEL CONSTRUCTION

- Gauge Of Steel: 16 Gauge Body; 16 Gauge Tailgate
- Removable Tailgate With Slotted Base



### 4 WHEEL STEERABLE CART

- Steerable Front Wheels Makes Moving Around The Farm Or Yard Easy

**2000** LBS MAX

### WEIGHT CAPACITY

- Fully Assembled Welded Pedestal & Under Carriage Frame



### TURF TIRES

- 16 x 6.5-8 Turf Tires With Metal Hub
- 3/4" Solid Steel Axle
- Maximum Speed 4 MPH

**TC-17-4**

Model #	Code #	Box Size	Shipping Weight	Carton Size	Shipping Class	Cubic Feet	Ship Via	wUPC Code
TC-17-4	5301398	17 Cu. Ft.	227#	61 x 39 x 17	85	23.4	LTL	733029003348

# FIMCO 4 FT PLANOGRAM LAYOUT



**PURCHASE AUTHENTIC  
REPLACEMENT PARTS  
& ACCESSORIES HERE**



**CONTACT YOUR FIMCO SALES REPRESENTATIVE TODAY FOR  
A CUSTOM FIMCO PLANOGRAM THAT SUITS *YOUR NEEDS***

# TEEJET 4 FT PLANOGRAM LAYOUT



**CONTACT YOUR FIMCO SALES REPRESENTATIVE TODAY FOR  
A CUSTOM FIMCO PLANOGRAM THAT SUITS *YOUR NEEDS***

# PACKAGED & REPLACEMENT PARTS

## WIRING



Part #	OEM Number	Description	UPC Code	Part Size	Part Weight
7771784	5278114	96" Lead Wire Assembly Alligator Clips	733029101617	3-5/8" x 6-5/8"	.48 lbs
7771786	5275053	96" Lead Wire Assembly Cigarette Lighter Adapter	733029101648	3-5/8" x 6-5/8"	.30 lbs
7771883	5273212	5' Extension for Lead Wire Assembly	733029102690	3-5/8" x 6-5/8"	.26 lbs
7771938	-	Remote Control On/Off Switch 12 Volt	733029103536	4-1/4" x 7"	.27 lbs

## TANK PARTS



Part #	OEM Number	Description	UPC Code	Part Size	Part Weight
7771950	5020524	Sprayer Hose 15 Feet	733029106859	10" x 10"	1 lb 13 oz
7772150	5020527	Sprayer Hose 25 Feet	733029122148	10" x 10"	.19.2 lbs
7771882	5053096, 5117334	Wand Clips (2 Pack)	733029102683	2-5/8" x 4-3/8"	.10 lbs
7772149	5133276	Hose Wrap	733029122131	3-5/8" x 6-5/8"	0.1 lbs
7771825	5168832, 5168833	Drain Cap and Tether	733029102195	2-5/8" x 4-3/8"	.04 lbs
7771826	5058188	Tank Lid	733029102201	8-3/4" x 9-3/4"	.58 lbs
7772014	-	Multi Lid	733029113665	7" x 7-1/4"	.68 lbs
7771592	5116242	Tank Strainers 2 Qty	733029100863	2-5/8" x 4-3/8"	.01 lbs
7772147	5116454	3/8" Hose Barb Strainer	733029122117	3-1/2" x 5-1/2"	.05 lbs
7772099	5116417	1" In Line Strainer Assy 1/2" MNPT	733029118110	3-5/8" x 6-5/8"	.03 lbs
7771873	5143419	Single Shutoff Valve	733029102527	3-1/2" x 5-1/2"	.05 lbs
7772138	-	3" x 6" Tank Repair Kit	733029121134	4 3/8" x 8 3/4"	0.1 lbs
5169262	-	15 Gallon Tank w/ Lid & Drain Cap	733029102874	34" x 14" x16"	12 lbs
5169264	-	25 Gallon Tank w/ Lid & Drain Cap	733029102881	40" x 16" x19"	20 lbs

## PUMP PARTS



Part #	OEM Number	Description	UPC Code	Part Size	Part Weight
7771824	5168832, 5168833, 5168836	Replacement Fittings for High Flo 2.1/2.4 GPM Pump	733029102379	3-1/2" x 5-1/2"	.10 lbs
7771831	5168832, 5168833	Pump Port (1) 1/2" Hose Barb, (1) 1/2" MPT	733029102393	3-1/2" x 5-1/2"	.05 lbs
7771913	5168836	Pump Port Fitting 3/8" Hose barb QTY 2	733029102829	2-5/8" x 4-3/8"	.05 lbs
7771830	5051162	Pump Port Clips 2 QTY	733029102386	2-5/8" x 4-3/8"	.01 lbs
7772088	5095202	Pump Feet for 1.0/1.2 and 2.1/2.4 GPM Pumps	733029116086	3-1/2" x 5-1/2"	.10 lbs
7771833	5143544	Pump Check Valve 2.1 and 2.4 GPM	733029102416	3-5/8" x 5-1/2"	.10 lbs
7771878	5168824	Pump Check Valve 3.8 and 4.5 GPM	733029102645	5-3/8" x 5-1/2"	.15 lbs
7772101	5164271	Pump Pressure Switch 1.2 and 4.5 GPM 60 PSI	733029118691	2-5/8" x 4-3/8"	.09 lbs
7771880	5157202	Pump Pressure Switch 2.1 and 2.4 GPM 60 PSI	733029102669	2-5/8" x 4-3/8"	.10 lbs

# PACKAGED & REPLACEMENT PARTS

## PLUMBING PARTS



Part #	OEM Number	Description	UPC Code	Part Size	Part Weight
7771967	See Kit	Manifold Kit	733029116079	8-3/4" x 9-3/4"	.09 lbs
7772087	See Kit	Manifold Repair Kit	733029116079	3-1/2" x 5-1/2"	.09 lbs
7771803	5167006	Pressure Gauge 0-60 PSI 2"	733029101914	3-1/2" x 5-1/2"	.24 lbs
7771804	5167007	Pressure Gauge 0-100 PSI 2"	733029101921	3-1/2" x 5-1/2"	.12 lbs
7771802	5167004	Pressure Gauge 0-200 PSI 2"	733029101907	3-1/2" x 5-1/2"	.12 lbs
7772086	5167097	Pressure Gauge 0-100 PSI 2" Back Mount	733029111067	3-5/8" x 6-5/8"	.13 lbs
7771778	5167031	Pressure Gauge 0-100 PSI 2 1/2" Liquid Filled	733029101495	3" x 5-1/8"	.45 lbs
7772130	5100959	Bypass Tube Kit Replacing 5100803	733029120618	11" x 5.25" x 1.75"	.20 lbs
7772131	5100960	Bypass Tube Kit Replacing 5149152	733029120625	10" x 9" x 2.5"	.35 lbs
7772132	5100961	Bypass Tube Kit Replacing 5100809	733029120632	6.75" x 3.75" x 1.75"	.10 lbs
7772133	5100962	Bypass Tube Kit Replacing 5149157	733029120656	6.75" x 5" x 1.5"	.15 lbs
7772134	5100963	Bypass Tube Kit Replacing 5100822	733029120663	6.75" x 5" x 1.5"	.15 lbs
7772135	5100964	Bypass Tube Kit Replacing 5100804	733029120670	6.75" x 5" x 1.5"	.15 lbs
7771829	5143204	3/4" GHT "Y" Valve	733029102270	3" x 5-1/8"	.10 lbs
7771342	5143335	Y Valve Zinc Coated GHT	733029002129	3" x 5-1/2"	.30 lbs
7771874	See Kit	PKG/Spot Spray Repair Kit	733029102584	3-3/4" x 5-1/2"	.16 lbs
7771876	See Kit	PKG/TRLR-ATV Repair Kit	733029102607	4-3/4" x 6-1/2"	.39 lbs

## BOOM PARTS



Part #	OEM Number	Description	UPC Code	Part Size	Part Weight
7771953	5056113	Nozzle Body "L" 3/8" Hose Barb Quick Connect	733029107398	3-1/2" x 5-1/2"	.08 lbs
7771954	5056114	Nozzle Body Tee 3/8" Hose Barb Quick Connect	733029107404	3-1/2" x 5-1/2"	.08 lbs
7771955	5056115	Nozzle Body Cross 3/8" Hose Barb Quick Connect	733029107411	3-1/2" x 5-1/2"	.08 lbs
7771956	5046251, 5106157	Fimco Black Nozzle Caps w/ Gaskets - 2 Pk	733029107428	3-1/2" x 5-1/2"	.05 lbs
7771766	5011657, 5046219	Nozzle Body Caps with Gasket 2 Qty	733029101358	3-1/2" x 5-1/2"	.08 lbs
7772145	5053110	Boom / Nozzle Retaining Clip - 2 PK	733029122094	2-5/8" x 4-3/8"	.05 lbs
7772148	5277923	1" Steel Boom Clamp - 2 PK	733029122124	5-3/8" x 5-1/2"	.05 lbs
7772146	5051114	1/2" Hose Clamps - 4 PK	733029122100	2 5/9" x 4 3/8"	.04 lbs
7771767	5018274	Replacement Tips TF-VP3 2 Qty	733029101365	2-5/8" x 4-3/8"	.01 lbs
7772089	5018371	Replacement Tips AIXR11002VP 2 Qty	733029116093	2-5/8" x 4-3/8"	.03 lbs
7771952	5018371	Replacement Tips AIXR11002VP 4 Qty	733029107381	2-5/8" x 4-3/8"	.03 lbs
7771769	5018265	Replacement Tips TP8002VP 2 Qty	733029101389	2-5/8" x 4-3/8"	.01 lbs
7771768	5018328	Nozzles - TP11002VP - 2 PK	733029101372	2-5/8" x 4-3/8"	.03 lbs
7771770	5116019	Nozzle Strainers - Old Style - 2 PK	733029101396	2-5/8" x 4-3/8"	.03 lbs
7772098	5143543	50 Mesh Check Valve Strainers - 2 PK	733029117519	2-5/8" x 4-3/8"	.05 lbs
7771884	5275123	Complete Replacement Boomless Nozzle Center	733029102706	3-5/8" x 6-5/8"	.31 lbs
7771885	5275122	Complete Replacement Boomless Nozzle Left or Right	733029102713	3-5/8" x 6-5/8"	.38 lbs
7771781	5274861	Replacement Cap/Tip for Left/Right Boomless Nozzle	733029101525	2-5/8" x 4-3/8"	.05 lbs
7771891	5088024	Boomless Nozzle Knob and Diaphragm	733029102775	2-5/8" x 4-3/8"	.04 lbs
7771875	See Kit	PKG/Boom Repair Kit	733029102591	3-3/4" x 5-1/2"	.19 lbs

# ATV QUICK RELEASE BOOM KITS



## 2-NOZZLE BOOM KIT



ATVBK-200-QR

**7 FT  
SPRAY  
COVERAGE**

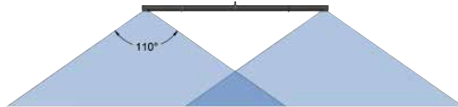

**TF-VP3 PREMIUM  
WIDE ANGLE  
INCLUDES NEW  
ANTI-DRIP STRAINER**



**MANIFOLD INCLUDED**



## 5-NOZZLE BOOM KIT



ATVBK-500-QR

**8 FT  
SPRAY  
COVERAGE**



**AIXR PREMIUM  
AIR INDUCTED  
INCLUDES NEW  
ANTI-DRIP STRAINER**



**MANIFOLD INCLUDED**



## 7-NOZZLE BOOM KIT



ATVBK-700-QR

**12 FT  
SPRAY  
COVERAGE**



**AIXR PREMIUM  
AIR INDUCTED  
INCLUDES NEW  
ANTI-DRIP STRAINER**



**MANIFOLD INCLUDED**



# ATV QUICK RELEASE BOOM KITS



## 7-NOZZLE DELUXE BOOM KIT



ATVBK-710-QR

**12 FT  
SPRAY  
COVERAGE**



**AIXR PREMIUM  
AIR INDUCED**  
INCLUDES CHEMSAVER  
DRIP-FREE SHUT OFF



**MANIFOLD INCLUDED**



## 3-NOZZLE BROADCAST BOOM KIT



ATVBK-3025-QR

**36 FT  
SPRAY  
COVERAGE**

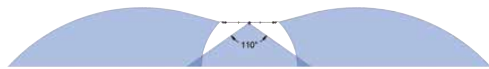

**XTENDER END TIPS  
& CENTER SPRAY TIP**  
INCLUDES DRIP-FREE  
SHUT OFF VALVES



**MANIFOLD INCLUDED**

Model #	Code #	Number Of Nozzles	Weight	Carton Size	Shipping Class	Cubic Feet	Ship Via	UPC Code
ATVBK-200-QR	5302339	2	18	54 x 11 x 6	150	2.0	GROUND	733029110770
- Minimum Pump Requirement - 1.2 G.P.M. DOES NOT INCLUDE TANK AND PUMP.								
ATVBK-500-QR	5302338	5	28	54 x 11 x 6	150	2.0	GROUND	733029110763
- Minimum Pump Requirement - 2.4 G.P.M. DOES NOT INCLUDE TANK AND PUMP.								
ATVBK-700-QR	5302337	7	29	53 x 11 x 6	150	2.0	GROUND	733029110756
- Minimum Pump Requirement - 2.4 G.P.M. DOES NOT INCLUDE TANK AND PUMP.								
ATVBK-710-QR	5302336	7	40	53 x 11 x 6	150	2.0	GROUND	733029110749
- Minimum Pump Requirement - 4.5 G.P.M. DOES NOT INCLUDE TANK AND PUMP.								
ATVBK-3025-QR	5302334	3	18	54 x 11 x 6	150	2.0	GROUND	733029110725
- Minimum Pump Requirement - 4.5 G.P.M. DOES NOT INCLUDE TANK AND PUMP.								

**KITS INCLUDE:** Pressure gauge, manifold & hose to convert your spot sprayer into an ATV sprayer.

# BOOM ASSEMBLIES

## 2 NOZZLE BOOM

The BK-1 boom assembly is for use on trailer sprayers with pressure controls & pressure gauge.



Model #	Code #	Description	Wt.
BK-1	5300954	2 Nozzle boom, w/brackets & feeder hose, 80" Coverage	14

## 5 NOZZLE BOOM

The BK-5 boom assembly is for use on trailer sprayers with pressure controls & pressure gauge.



Model #	Code #	Description	Wt.
BK-5	5300955	5 Nozzle, 3 section break-away boom, w/brackets & feeder hose, 100" Coverage	26

## 7 NOZZLE BOOM

The BK-70 boom assembly is for use on 3-point, ATV, and trailer sprayers with pressure controls & pressure gauge.



Model #	Code #	Description	Wt.
BK-70	5301197	7 Nozzle, 3 section break-away boom, 140" Coverage	28

## 3-NOZZLE BROADCAST BOOM

The BK-3025BL boom assembly is for use on 3-point, ATV, and trailer sprayers.



Model #	Code #	Description	Wt.
BK-3025BL	5301289	3-Nozzle Broadcast Boom, Up to 30 ft Coverage	28



# ACCESSORIES

## MULTI-LID

- Food grade, 32 ounce measuring cup is attached to tank lid
- Garden hose port secures hose for safe and easy filling with one person
- Fits sprayers with a 5" tank lid
- Made in the USA



Model #	Code #	Carton Size	Shipping Class	UPS Able	UPC Code
Multi-Lid	7772014	7" x 7" x 7.5"	85	2#	733029113665



## 12 VOLT ON/OFF WIRELESS REMOTE CONTROL

CONTROLS ALL 12 VOLT PRODUCTS UP TO 20 AMPS!

### FEATURES:

- Wireless Remote
- Convenient Keychain Clip
- 2-way, 2 Wire Flat Molded Connectors, 16 Gauge Wire

Model #	Description	UPC Code	Part Size
7771938	12 Volt On/Off Wireless Remote Control	733029103536	4.25" x 7"

## ON/OFF SWITCH KIT

Can be used on all sprayers with 12 volt electric pumps. Connects between battery and pump wiring and turns sprayer "on" or "off" from the operators seat.



5278017



5278114



5275053



5273212



5277040

Code #	Description	Wt.
5278017	96" Wire W/Switch (5 Amp) Only For Use With 1.2 GPM Pumps	1
5278114	96" Wire W/Switch (15 Amp)	1
5275053	10' Wire Assy W/ Lighter Adapter & Switch	1
5273212	5' Extension Cable	1
5277040	10' Heavy Duty Wire Assy	1

# 12 VOLT PUMPS



- 1.0 GPM 12 Volt Electric Pump
- Maximum Pressure Of 60 PSI
- Pressure Switch Turns Pump On & Off
- Self Priming
- Can Run Dry Without Damage

**1.0 G.P.M.**

Boxed Part #	Individual Part #	Volts	Amps	Demand Switch or Relief Valve	Max Pressure	GPM	UPC Code
5151118	5281560	12	4	Demand Switch	60	1.0	733029120083



## HIGHFLO HIGH PERFORMANCE

- 1.2 G.P.M. High Performance 12 Volt Pump
- 60 PSI Max Pressure
- Quick Connect Hose Fittings
- In-Line Fuse Protection
- 12 Volt Dc Power
- Self Priming - 8 Ft To 14 Ft
- Runs Dry Without Damage
- Chemical Resistant Elastomers
- 3/8" Hose Barbs
- Fan Cooled Motor

**1.2 G.P.M.**

- DEMAND SWITCH MODELS operate only when liquid flow is required. Pump and motor stop instantly when discharge is closed.
- Diaphragm design eliminates troublesome shaft seal.
- Pump can be run indefinitely without damage.
- Ball bearing drive - assures longer pump life.
- Excellent self-priming capability.
- Santoprene diaphragms and viton valves are standard.
- Maximum temperature of pumped liquid 130°F.
- Permanent magnet motor - long life brushes.
- Fuse Protected
- Built-In cooling fan

**2 YEAR WARRANTY**

Boxed Part #	Individual Part #	Volts	Amps	Demand Switch or Relief Valve	Max Pressure	GPM	UPC Code
5151086	5281370	12	4.0	Demand Switch	60	1.2	733029118134 (Boxed)



## HIGHFLO HIGH PERFORMANCE

- 2.4 G.P.M. High Performance 12 Volt Pump
- 60 PSI Max Pressure
- Quick Connect Hose Fittings
- In-Line Fuse Protection
- 12 Volt Dc Power
- Self Priming - 8 Ft To 14 Ft
- Runs Dry Without Damage
- Chemical Resistant Elastomers
- 3/8" Hose Barbs
- Fan Cooled Motor

**2.4 G.P.M.**

- DEMAND SWITCH MODELS operate only when liquid flow is required. Pump and motor stop instantly when discharge is closed.
- Diaphragm design eliminates troublesome shaft seal.
- Pump can be run indefinitely without damage.
- Ball bearing drive - assures longer pump life.
- Excellent self-priming capability.
- Santoprene diaphragms and viton valves are standard.
- Maximum temperature of pumped liquid 130°F.
- Permanent magnet motor - long life brushes.
- Fuse Protected
- Built-In cooling fan

**2 YEAR WARRANTY**

Boxed Part #	Individual Part #	Volts	Amps	Demand Switch or Relief Valve	Max Pressure	GPM	UPC Code
5151087	5281371	12	8.0	Demand Switch	60	2.4	733029118073 (Boxed)



## HIGHFLO HIGH PERFORMANCE

- Internal Bypass Pump; 2.4 G.P.M.
- Pumps Until Power Is Shut Off
- 60 P.S.I. Max Pressure
- 8 Amp Draw
- Quick Connect Hose Fittings

**2.4 G.P.M. BYPASS**

- DEMAND SWITCH MODELS operate only when liquid flow is required. Pump and motor stop instantly when discharge is closed.
- Diaphragm design eliminates troublesome shaft seal.
- Pump can be run indefinitely without damage.
- Ball bearing drive - assures longer pump life.
- Excellent self-priming capability.
- Santoprene diaphragms and viton valves are standard.
- Maximum temperature of pumped liquid 130°F.
- Permanent magnet motor - long life brushes.
- Fuse Protected
- Built-In cooling fan

**2 YEAR WARRANTY**

Boxed Part #	Individual Part #	Volts	Amps	Demand Switch or Relief Valve	Max Pressure	GPM	UPC Code
5151089	5281373	12	8.0	Relief Valve	60	2.4	733029118097 (Boxed)

# 12 VOLT PUMPS



## HIGH FLO HIGH PERFORMANCE

- 4.5 G.P.M. High Performance 12 Volt Pump
- 60 PSI Max Pressure
- Quick Connect Hose Fittings
- In-Line Fuse Protection
- 12 Volt Dc Power
- Self Priming - 8 Ft To 14 Ft
- Runs Dry Without Damage
- Chemical Resistant Elastomers
- 3/8" Hose Barbs
- Fan Cooled Motor

- DEMAND SWITCH MODELS operate only when liquid flow is required. Pump and motor stop instantly when discharge is closed.
- Diaphragm design eliminates troublesome shaft seal.
- Pump can be run indefinitely without damage.
- Ball bearing drive - assures longer pump life.
- Excellent self-priming capability.
- Santoprene diaphragms and viton valves are standard.
- Maximum temperature of pumped liquid 130°F.
- Permanent magnet motor - long life brushes.
- Fuse Protected
- Built-in cooling fan

**2 YEAR  
WARRANTY**

**4.5 G.P.M.**

Boxed Part #	Individual Part #	Volts	Amps	Demand Switch or Relief Valve	Max Pressure	GPM	UPC Code
5151088	5281372	12	11.0	Demand Switch	60	4.5	733029118080 (Boxed)



## HIGH FLO PRO SERIES 12 VOLT DIAPHRAGM PUMPS PROFESSIONAL GRADE HFP-2.2 G.P.M.

- 100 P.S.I.
  - Viton Valves
  - Geolast Diaphragm
  - Two Pin Connector 6" Long
- Upgraded components - Ideal For:
- Harsh Chemicals & Oil Based Chemicals With Surfactants
  - Heavy Duty Motor

**HFP 2.2 G.P.M.**

Boxed Part #	Individual Part #	Volts	Amps	Demand Switch or Relief Valve	Max Pressure	GPM	UPC Code
5281325	5151075	12	4	Demand Switch	100	2.2	733029117601



## HIGH FLO PRO SERIES 12 VOLT DIAPHRAGM PUMPS PROFESSIONAL GRADE HFP-4.0 G.P.M.

- 45 P.S.I.
  - Viton Valves
  - Geolast Diaphragm
  - Two Pin Connector 6" Long
  - 1/2"-14NPT Male Threads
- Upgraded components - Ideal For:
- Harsh Chemicals & Oil Based Chemicals With Surfactants
  - Heavy Duty Motor

**HFP 4.0 G.P.M.**

Boxed Part #	Individual Part #	Volts	Amps	Demand Switch or Relief Valve	Max Pressure	GPM	UPC Code
5281326	5151073	12	11	Demand Switch	45	4.0	733029117618

# SPRAY WANDS

## 22" & 13" PRO SERIES LONG RANGE ERGONOMIC SPRAY WANDS

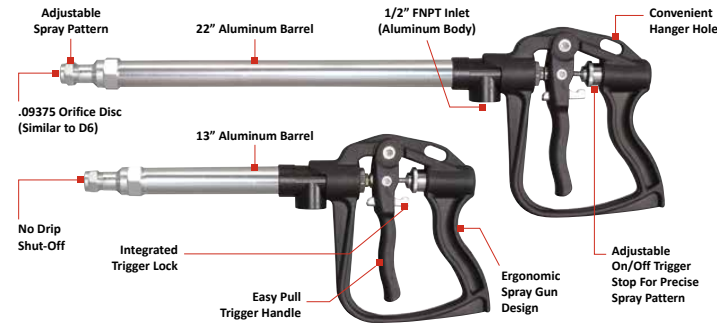

### Other Features

- 600 PSI
- 8 GPM
- Chemical Resistant Construction



### Spray Distance

- 38' Max Horizontal
- 27' Max Vertical

FIMCO Code #	Description	UPC Code
5163136	22" Long Range Pro Series Spray Wand	733029115782
5163137	13" Long Range Pro Series Spray Wand	733029115799
7772092	End Cap Replacement Kit (End Cap, Gasket, Orifice Disc)	733029116901
7772093	Repair Kit (O-Ring, Valve Core Assembly)	733029116918

## DELUXE SPRAY WAND



- Flow Rates Up to 5 G.P.M.; 300 P.S.I.
- Comfortable Pistol Grip Spray Wand
- 18" Aluminum Wand
- 3/8" Hose Barb
- Adjustable Pattern Tip (Cone to Straight Stream)

MFG Part #	Description	Weight	UPC Code
5273959	Spray Wand w/X-26 Tip	0.8 lbs	733029100306
5018331	X-26 Tip Only (Brass)	0.09 lbs	733029104649

## ERGONOMIC SPRAY WAND



- Overall Wand Length is 29"
- Metal Extension is 19" Long w/30° Offset Tip
- Hose Shank Connection is 3/8"
- Tip Has Adjusting Pattern From Cone Spray To Straight Stream
- Maximum Operating Pressure is 100 P.S.I.
- Ergonomic Handle With Trigger Locks For Continuous Operation

FIMCO Code #	Description	Weight	UPC Code
5163155	Ergonomic Spray Wand	0.5 lbs	733029124982

## STANDARD LEVER SPRAY WAND



- Overall Wand Length is 29"
- Metal Extension is 19" Long w/30° Offset Tip
- Hose Shank Connection is 3/8"
- Tip Has Adjusting Pattern From Cone Spray To Straight Stream
- Maximum Operating Pressure is 100 P.S.I.
- Trigger Locks For Continuous Operation

FIMCO Code #	Description	Weight	UPC Code
5163100	29" Trigger Wand	0.5 lbs	733029101136
5018330	X-26 Tip Only (Poly)	0.02 lbs	733029105622
7771944	Economy Spray Wand With Hangtag	0.5 lbs	733029104304

# SPRAY WANDS

## LEVER GRIP SPRAY WAND



- Up to 25 Feet Horizontal Spray
- Up to 15 Feet of Vertical Spray
- Adjustable Spray Pattern

Code #	Description	Wt.	UPC Code
5163154	Value Lever Grip Spray Wand	0.3 lbs	733029122216

## LAWN GUARD SPRAY WAND



- 3.6V Rechargeable Lithium Ion Spray Wand
- Built-In Pump
- 65 Minute Run Time / Charge
- 10 ft Vertical Spray, 20 ft Horizontal Spray



Model #	Code #	UPC Code
7772105	7772105	733029120212

## HIGH-FLO SPRAY WAND

- 25 Feet of hose gives you the length necessary to reach tight areas, around buildings and other obstacles
- Deluxe pistol grip spray wand delivers up to 40 feet of horizontal spray and 25 feet of vertical spray and features an ergonomic polymer handle and precision brass tip.



Code #	Description	Wt.	UPC Code
7771827	Standard Spray Wand W/15' Of Spiral Hose	1.21 lbs	733029102249

## TELESCOPIC SPRAY WAND - GREAT FOR TREES, HOUSES AND OTHER HARD TO REACH PLACES!

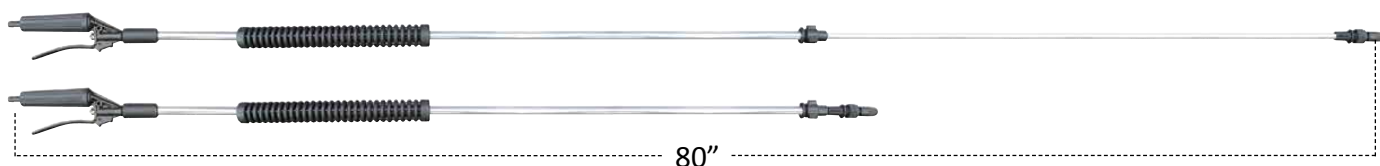

- Hose Shank Connection is 3/8"
- Tip Has Adjusting Pattern From Cone Spray To Straight Stream
- Maximum Operating Pressure is 100 P.S.I.
- Trigger Locks For Continuous Operation

FIMCO Code #	Description	Weight	UPC Code
5163117	Telescoping Wand	1.25 lbs.	733029102218

# HOSE REELS

## HOSE REEL ATTACHMENT FOR 45/65 UTV SPRAYER

- Designed to work exclusively with your FIMCO UTV sprayers
- Heavy duty construction provides years of trouble free use
- Pivoting spool with locking feature allows you to rotate your hose and lock it in place, unwinding your hose in the direction you need



MFG Part #	FIMCO Part #	Inlet/Outlet	Reel Capacity In Feet	PSI
UTV-HR-50	5302886	3/8" Hose Barb 50' of 3/8" Hose	50' of 3/8"	300

## LOW PRESSURE COX REEL

- Heavy duty 1/4" plate steel support post and mounting plate
- 1" Oil-lite self lubricating bearing
- Solid 1" steel center support shaft
- Full flow swivel joint
- Adjustable arm guide (wall, floor, ceiling and pit)
- Cartridge style spring motor
- 4 Roller non-sag hose guide
- Eight position locking ratchet



MFG Part #	FIMCO Part #	Hose ID	Hose OD	Ft	PSI
P-LP-350	5274152	3/8"	21/32"	50	300
P-LP-415	5274153	1/2"	27/32"	15	300

## GENERAL PUMP HAND CRANK REEL



MFG Part #	FIMCO Part #	Inlet/Outlet	Reel Capacity In Feet	PSI
D30006	5277374	3/8" NPT-M 3/8" NPT-F	200' of 3/8"	3500

## COX 12 VOLT ELECTRIC REEL (Gear Driven)



MFG Part #	FIMCO Part #	Inlet/Outlet	Reel Capacity In Feet	PSI
1125-4-325E	5274305	1/2"	450' of 3/8" 325' of 1/2"	3000

## COX HAND CRANK REEL



MFG Part #	FIMCO Part #	Inlet/Outlet	Reel Capacity In Feet	PSI
1125-4-325	5274304	1/2"	450' of 3/8" 325' of 1/2"	3000

## 1526-17-18

- 1/2 FNPT Inlet & Outlet
- 3000 PSI Max. Pressure
- Optional Guide Rollers & Mounting Bracket
- Holds 300 Ft of 1/2" ID. x 7/8" OD. Hose
- Temperature Range -20° to 400°



MANUAL REWIND HOSE REELS	Model #	Shipping Bundle #	Description	Weight
	1526-17-18	5272182	Hannay Manual Rewind Hose Reel Crank is Permanently Attached to the Reel Axle on this Model	38
OPTIONS	Model #	Shipping Bundle #	Description	Weight
	5274195-BLK	5274195	Mounting Stand for Hose Reels	



# TANK ADDITIVES

## SPRAYER TANK NEUTRALIZER & CLEANER



Fimco's Tank Neutralizer cleaning agent is specifically designed to clean sprayers. Removes dirt, scale and rust from spray booms and tanks, as well as neutralizing the chemical action of spray chemicals previously used in your equipment. A completely soluble powder.

Recommended to be used for flushing sprayers after each use. Reduces corrosion in tanks and pumps.

Code #	Description	Weight	UPC Code
5173029	2 lb. Can (Packed 12 per Case)	2 lbs	733029102362

## SCHABEN'S SUPER FOAM



Long lasting foam. Holds up to hard water, highwinds and high temperatures. 160 to 1 concentrate

FIMCO Code #	Description
SUPERFOAM1 (5173032)	1 Gallon
SHP-SUPERFOAM4-KIT	4-1 Gallon

## SUPER SIGNAL BLUE



Super concentrated, blue spray pattern indicator formulated to provide visual evidence of where a spray application has been made Broadcast: 16 to 32 oz/100 gallons Handheld: 1 to 2 oz/3 gallons

FIMCO Code #	Description
7772152	1 Quart
SUPERSIGNALBLUE/2.5	2.5 Gallons

## FOAM COLORANTS



Pour it in your foamer along with your foam concentrate. It leaves a bright colored mark long after the foam is gone. Mix Rate = 2 oz to 10 gallons.

FIMCO Code #	Description
7772151	Pink (32 oz)

# HYPRO SPRAYER PUMPS

IMPORTANT NOTE: Use cast iron pumps for general spraying. Use Ni-Resist and XL (Silver series) pumps for liquid fertilizers, soil fumigants and insecticides containing phosphates.  
Repair Kits Include Super Rollers, Viton Seals & O-Ring Gasket.

# HYPRO®

## SERIES 6500 (6 ROLLER) SPRAYER PUMP FITS (540 & 1000 RPM PTO SHAFTS)



Super Roller Equipped  
Along with the 7560, the Series 6500 is one of the most widely used pumps on farms today. It's an economical way to handle: water, herbicides, insecticides, emulsions, aromatic solvents, fertilizer, and wettable powder.

9.76 GPM at 540 RPM - 18.2 GPM at 1000 RPM  
- Max Pressure 300 PSI - Max Speed 1200 RPM -  
Max Output 21.8 GPM

Code #	MFG Part #	Description
7771795	3430-0380	Repair Kit

## SERIES 7560 (8 ROLLER) SPRAYER PUMP (540 & 1000 RPM PTO SPEEDS)



Super Roller Equipped The Series 7560 offers a variety of choices in materials for rollers, shaft seals and pump housing. The choice reflects your pumping needs: water, herbicides, insecticides, emulsions, aromatic solvents, fertilizer and wettable powder. Heavy duty construction with 15/16" diameter steel shaft.

12 GPM at 540 RPM - 22.5 GPM at 1000 RPM. Max Pressure 300 PSI - Max Speed 1200 RPM

Code #	MFG Part #	Description
7771794	3430-0381	Repair Kit

## SERIES 7700 (7 ROLLER) PUMP (MAX. 800 RPM)



Super Roller Equipped  
Plenty of pump for both spraying and agitation — 13 G.P.M. at 50 P.S.I. at 540 rpm PTO speed. Designed for wettable powder herbicides and insecticides. Avoids clogging and helps assure a proper and uniform mix.

Max. Output to 22.1 GPM - Pressure to 200 PSI. Max. Speed 800 RPM - Temperature to 140° F.

Code #	MFG Part #	Description
7771799	3430-0384	Repair Kit

## SPECIFICATIONS FOR ROLLER PUMPS

Series	MAX GPM	MAX PSI	MAX RPM	SHAFT		Ports Size	Roller Material	Standard Seal	Length	Width	Height
				Height	Diameter Style						
1500	62	150	1000	5"	15/16" Solid	1-1/2" (F)NPT	Super Roller	Buna-N	7-11/16"	8-3/4"	8-1/8"
1700	45	200	1000	3-3/8"	15/16" Solid	1" (F)NPT	Super Roller	Viton	7-23/32"	8-1/4"	6-7/32"
4001	9	150	1800	1-3/4"	5/8" Solid	3/4" (F)NPT	Super Roller	Viton	5-11/32"	4-5/8"	3"
4101	7	150	2600	1-3/4"	5/8" Solid	3/4" (F)NPT	Super Roller	Viton	5-11/32"	4-5/8"	3"
6500	21.8	300	1200	3-5/32"	5/8" Solid	3/4" (F)NPT	Super Roller	Viton	5-11/32"	6"	5-1/2"
7560	22	300	1000	3-3/8"	15/16" Solid	3/4" (F)NPT	Super Roller	Viton	6-13/16"	6-5/8"	5-15/16"
7700	22.1	200	800	3-1/2"	15/16" Solid	3/4" (F)NPT	Super Roller	Viton	6-7/8"	6-5/8"	6"

FIMCO Code #	MFG Part #	Description
5271706	6500C-A	Cast Iron Pump Less Coupler
5271712	6500N-A	Ni-Resist Pump Less Coupler
5272446	*6500C-AR	Cast Iron Pump Reverse Rotation
5273024	6500XL-A	Silver Series Pump Less Coupler
5168226	3420-0023	Base Kit (Fits All 6500 Pumps)
5005047	1320-0022	540 RPM Standard Coupler
5057145	1321-0012	540 or 1000 RPM Quick Coupler
5057031	1321-0006	540 RPM Quick Coupler
5057033	1321-0008	1000 RPM Quick Coupler

\*For Use With Gasoline Engine

FIMCO Code #	MFG Part #	Description
5271077	7560C-A	Cast Iron Pump Less Coupler
5271081	7560N-A	Ni-Resist Pump Less Coupler
5271509	*7560C-AR-01	Cast Iron Pump Reverse Rotation
5273025	7560XL-A	Silver Series Pump Less Coupler
5168050	3420-0003	Base Kit (Fits All 7560 Pumps)
5057146	1321-0013	540 or 1000 RPM Quick Coupler
5057032	1321-0007	540 RPM Quick Coupler
5057034	1321-0009	1000 RPM Quick Coupler

\*For Use With Gasoline Engine

FIMCO Code #	MFG Part #	Description
5271085	7700C-A	Cast Iron Pump Less Coupler
5273026	7700XL-A	Silver Series Pump Less Coupler
5057032	1321-0007	540 RPM Quick Coupler

# HYPRO SPRAYER PUMPS

## SERIES 1700 (5 ROLLER) PUMPS (540 & 1000 RPM PTO SPEEDS)



Super Roller Equipped. The 1700 Series handles a variety of liquids: water, herbicides, insecticides, emulsions, aromatic solvents, fertilizer and wettable powder. Use where moderate flow and pressure is desirable. Output to 45 GPM - Pressure to 200 PSI - Speed to 1000 RPM - Temperature to 140° F

Code #	MFG Part #	Description
5168816	3430-0383	Repair Kit

## SERIES 1500 (6 ROLLER) PUMPS (540 & 1000 RPM PTO SPEEDS)



Super Roller Equipped. Series 1500 adapts to 1-3/8" or 1-3/4" 1000 RPM PTO shafts as well as 540 RPM. It can be used with a large variety of chemicals. Output to 62 GPM - Pressure to 150 PSI - Speed to 1000 RPM - Temperature to 140° F

Code #	MFG Part #	Description
5168817	3430-0386	Repair Kit

## SERIES 4001/4101 (4 ROLLER)

SMALL, DURABLE, LOW-COST PUMPS WITH MANY INDUSTRIAL USES



Super Roller Equipped. Use Series 4001/4101 as a "pressure" pump for spraying, atomizing or blending insecticides, herbicides, fumigants, etc., or as a transfer pump for water, brine, oils, solvents, and many chemicals, or as a circulating pump for lubricants, coolants, and rinsing solutions. Series 4001, for electric motor drive

Code #	MFG Part #	Description
7771796	3430-0390	Repair Kit

## POWER TAKE OFF COUPLERS

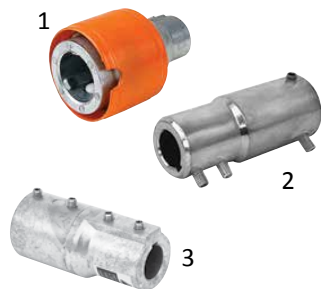

Item	FIMCO Code #	MFG Part #	Description
1	5057145	1321-0012	Hypro Quick Coupler-Fits 5/8" Shaft (540 or 1000 RPM PTO)
1	5057031	1321-0006	Hypro Quick Coupler-Fits 5/8" Shaft (540 RPM PTO)
1	5057146	1321-0013	Hypro Quick Coupler-Fits 15/16" Shaft (540 or 1000 RPM PTO)
1	5057032	1321-0007	Hypro Quick Coupler-Fits 15/16" Shaft (540 RPM PTO)
1	5057033	1321-0008	Hypro Quick Coupler-Fits 5/8" Shaft (1000 RPM PTO)
1	5057034	1321-0009	Hypro Quick Coupler-Fits 15/16" Shaft (1000 RPM PTO)
2		1323-0076	Forged Steel Coupler-Fits 15/16" Shaft (540/1000 RPM PTO)
2		1323-0077	Forged Steel Coupler-Fits 5/8" Shaft (540/1000 RPM PTO)
3	5005047	1320-0022	Standard Coupler-Fits 5/8" Shaft (540 RPM PTO) 6 Spline
3	5005245	1320-0080	Standard Coupler-Fits 15/16" Shaft (1-3/4" 1000 RPM PTO)
	5005175	1320-0016	5/8" x 5/8" Adapter Kit
	5005240	1320-0015	3/4" x 5/8" Adapter Kit
	5026011	3250-0004	Quick Coupler. Balls Only
	5005245		1-3/4" Forged Steel PTO Adapter
	5005247		1-3/8" Forged Steel PTO Adapter
	3430-0540		Torque Arm Kit for Roller Pumps

FIMCO Code #	MFG Part #	Description
5271710	1700C-A	Cast Iron Pump Less Coupler
5271709	1700N-A	Ni-Resist Pump Less Coupler
5273027	1700XL-A	Silver Series Pump Less Coupler
5057032	1321-0007	540 RPM Quick Coupler
5057034	1321-0009	1000 RPM Quick Coupler
5005245	1320-0080	1000 RPM 1-3/4" Coupler

FIMCO Code #	MFG Part #	Description
5271539	1502C-A	Cast Iron Pump Less Coupler
5273028	1502XL-A	Silver Series Pump Less Coupler
5005246	1320-0033	540 RPM Standard Coupler
5057032	1321-0007	540 RPM Quick Coupler
5057034	1321-0009	1000 RPM Quick Coupler
5005245	1320-0080	1000 RPM 1-3/4" Coupler

FIMCO Code #	MFG Part #	Description
(The Following Pumps Operate up to 1800 RPM)		
5271759	4001C-A	Cast Iron Pump 5/8" Solid Shaft
5271760	4001N-A	Ni-Resis Pump 5/8" Solid Shaft
5273029	4001XL-A	Silver Series Pump 5/8" Solid Shaft
(The Following Pumps Operate up to 2600 RPM)		
5271757	4101C-A	Cast Iron Pump 5/8" Solid Shaft
5271758	4101N-A	Ni-Resist Pump 5/8" Solid Shaft
5273030	4101XL-A	Silver Series Pump 5/8" Solid Shaft
5005175	1320-0016	5/8" Sleeve Coupler Direct To Engine Mount
5168259	3420-0025	Base Kit For Gas Engine - 4-3/16" Shaft Centerline

# HYPRO®

# HYPRO CENTRIFUGAL PUMPS

## SERIES 9200 PEDESTAL MODELS



FIMCO Code #	MFG Part #	Max GPM	Max PSI	Max RPM	Description	Shpg Wt.
5271967	9202C	105	170	6000	Cast Iron - 5/8" Solid Shaft w/Viton Shaft Seal Ports (NPT): 1-1/4" Inlet, 1" Outlet	18 lbs.
5271968	9203C	140	170	6000	Cast-Iron - 5/8" Solid Shaft w/Viton Shaft Seal Ports (NPT): 1-1/2" Inlet, 1-1/4" Outlet	19 lbs
5272579	9203C-R	140	170	6000	Cast Iron -with 5/8" solid shaft, counter clockwise rotation viton seal, and 1-1/2" x 1-1/4" Ports	17 lbs.
5275540	9206C	225	80	4200	Cast iron - with 5/8" solid shaft and Viton Seal, Ports (NPT): 2" Inlet, 1-1/2 Outlet	23 lbs.

## POLYPROPYLENE CENTRIFUGAL PUMP (GEAR DRIVEN PTO)



FIMCO Code #	MFG Part #	Max GPM	Max PSI	Max RPM	Description	Shpg Wt.
5272451	9006P-O	97	83	540	Gears are safely enclosed in the factory lubricated case. It is available in a gear drive for 540 RPM for coupling to standard PTO.	37 lbs.

## POLYPROPYLENE CENTRIFUGAL PUMP (PEDESTAL MOUNTED)



FIMCO Code #	MFG Part #	Max GPM	Max PSI	Max RPM	Description	Shpg Wt.
5272453	9203P-S	100	80	4200	The pedestal mounted centrifugal pump is designed for direct drive with an electric motor or belt and pulley drive with an electric motor or gas engine. It has a 7/8" keyed 316 Stainless Steel Shaft.	13 lbs.

## POLYPROPYLENE CENTRIFUGAL PUMPS (HYDRAULIC MOTOR DRIVEN)



FIMCO Code #	MFG Part #	Max GPM	Max PSI	Max RPM	Description	Shpg Wt.
5273217	9303P-HM1C	110	130	Open / Closed	The hydraulic motor features a fixed displacement internal gear design for smooth operation. A double lip Teflon shaft seal provides excellent reliability even with hydraulic oil back pressure. The hardened stainless steel motor/pump shaft is supported by two needle bearings and a ball bearing for dependable operation through years of use.	20 lbs.
5272455	9303P-HM4C	82	85	Open / Closed		19 lbs.

PLEASE CONTACT US FOR ANY SPECIAL ORDER HYPRO PRODUCT REQUESTS

# ACE CENTRIFUGAL PUMPS

## PTO DRIVEN CENTRIFUGAL PUMPS



FIMCO Code #	MFG Part #	Description	Wt
5271573	PTOC-600-6SP	Cast iron 1-1/4" x 1" straight centrifugal with pulleys and 10 groove belt arranged for direct mounting on 1-3/8 600RPM PTO shaft, 0-70 PSI. Equipped with 6 spline PTO drive shaft. Viton mechanical seal. Fully guarded for operator safety.	45
5271574	PTOC-600-QC	Cast iron 1 1/4" x 1" straight centrifugal with pulleys and 10 groove belt arranged for direct mounting on 1-3/8" 600RPM PTO shaft 0-70 PSI. Equipped with 6 spline quick coupler PTO drive shaft. Viton mechanical seal. Fully guarded for operator safety.	46
5271940	PTOC-600-B	Cast iron 1 1/4" x 1" straight centrifugal with pulleys and 10 groove belt. 1" Diameter stub shaft and integral mounting base 600 RPM Tumblerod drive shaft. 0-70 PSI. Equipped with Viton mechanical seal. Fully guarded for operator safety.	42
5271543	PTOC-1000-21SP	Cast iron 1 1/4" x 1" straight centrifugal with pulleys and 10 groove belt arranged for direct mounting on 1 3/8"1000 RPM PTO shaft. 0-70 PSI. Equipped with 21 spline split PTO drive shaft and split ring locking collar. Viton mechanical seals. Fully guarded for operator safety.	43
5271822	PTOC-1000-20SP	Cast iron 1 1/4" x 1" straight centrifugal with pulleys and 10 groove belt arranged for mounting on 1 3/4" 1000 RPM PTO shaft. 0-70 PSI. Equipped with split PTO drive shaft and split ring locking collar, Viton mechanical seals. Fully guarded for operator safety.	45
5273035	PTOC-150-600-6SP	0-100 PSI cast iron straight centrifugal with pulleys and 10 groove belt assembled for mounting on 1-3/8", 600 RPM PTO shaft. Viton mechanical seal. Fully guarded for operator safety.	51
5273036	PTOC-150-600-6SPQC	0-100 PSI cast iron straight centrifugal with pulleys and 10 groove belt assembled for mounting on 1-3/8", 600 RPM PTO Shaft; equipped with Quick Coupler. Viton mechanical seal. Fully guarded for operator safety	51
5273037	PTOC-150-1000-21SP	0-100 PSI, cast iron straight centrifugal with pulleys and 10 groove belt assembled for direct mounting on 1-3/8" 1000 RPM PTO Shaft. Equipped with 21 spline PTO shaft and locking collar. Viton Mechanical seal. Fully guarded for operator safety.	48
5273038	PTOC-150-1000-20SP	0-100 PSI, cast iron straight centrifugal with pulleys and 10 groove belt assembled for mounting on 1-3/4" 1000 RPM PTO shaft. Equipped with 20 spline PTO shaft and locking collar. Viton mechanical seal. Fully guarded for operator safety.	50

## CENTRIFUGAL PUMPS - TRACTOR HYDRAULIC SYSTEM DRIVEN

Cast iron 1 1/4" x 1" frame mounted straight centrifugal pump for tractor hydraulic system applications. Assembled with hydraulic motor equipped with internal check valve to prevent reverse rotation and resulting seal damage. Also equipped with integral needle valve to control input of fluid on open center tractor hydraulic systems and a restrictor orifice to control input of fluid on closed center systems is included with Model FMC-HYD-204. (Models FMC-HYD-210 and FMC-HYD-310 are not equipped with restrictor orifice). To match pump model with tractor hydraulic system capacity, refer to chart below. Models FMC-HYD-204 and FMC-HYD-210 produce 0-100 PSI at maximum 4600 RPM and 60 GPM at open discharge. Model FMC-HYD-310 produces 0-65 PSI at maximum 3950 RPM and 60 GPM at open discharge. For open center systems which

require sprayer pump pressures of from 60 to 100 PSI, pump model FMC-HYD-210 should be selected where the tractor system has a minimum of 8 GPM at 500 PSI available at the remote ports.

The New Model No. FMC-150-HYD-206 has 1-1/2" x 1-1/4" ports. Maximum pressure 120 PSI at 5100 RPM at open discharge. 7 GPM hydraulic motor can be used on pressure compensating Closed Center Systems (John Deere Type), Load Sensing Closed Center Systems (Case-IH type), and Open Center Systems Rated 7-16 GPM. Equipped with restrictor Orifice.

++ Indicates which Pumps may be used with which Hydraulic Systems

## TRACTOR HYDRAULIC SYSTEM REMOTE OUTLET CAPACITY (GPM)

FIMCO Code #	MFG Part #	Pressure Compensating CLOSED SYSTEM (John Deere Type)	Load Sensing CLOSED SYSTEM (Case-IH Type)	OPEN CENTER	Wt
5271132	FMC HYD 204	++		++ 4-13 GPM	26
5271733	FMC HYD 210		++	++ 8-17 GPM	27
5271734	FMC HYD 310			++ 18-24 GPM	33
5273039	FMC-150-HYD-206	++	++	++ 7-16 GPM	31

## FRAME MOUNTED CENTRIFUGAL PUMP - COUNTER-CLOCKWISE ROTATION

FIMCO Code #	MFG Part #	Description	Wt
5271128	FMC-MIA	Cast iron 1 1/4" x 1" frame mounted straight centrifugal pump for belt drive application. 0-100 PSI at maximum 4600 RPM, 60 GPM at open discharge. Equipped with Viton mechanical seal. Mounting frame machined for idler arm.	18

# PARTS LIST FOR ACE CENTRIFUGAL PUMPS

## TRACTOR PTO DRIVEN

PUMP REPAIR KITS: Includes Belt, VITON Seal, Gaskets & "O" Ring

**5168204** (RK-PTOC-600)  
for Models PTOC-600-6SP, PTOC-600-QC and PTOC-600-B

**5168205** (RK-PTOC-1000)  
for Models PTOC-1000-21SP and PTOC-1000-175-20-SP



Ref	FIMCO Code #	MFG Part #	Description	Req
1	5072114	BAC-4	Gasket, 4 Hole	1
2	5019087	BAC-5	Idler Torsion Spring	1
3	5118118	BAC-6-SS	5/8" Shaft, L. H. Thread, Stainless (Optional)	1
4	5072129	BAC-7B	Buna N Seal (Optional)	1
4	5072115	BAC-7V	VitonSeal	1
4	5072130	40160	"O" Ring For BAC-6 Shaft	1
5	5118136	BAC-10-6-SP	1 3/8" 6 Spline PTO (For PTOC-600-10-6SP)	1
6	5128001	BAC-10-6SP-QC	1 3/8" 6 Spline PTO (For PTOC-10-QC)	1
7	5118137	BAC-10-21SP	1 3/8" 21 Spline PTO (For PTOC-1000-10-21SP)	1
8	5118146	BAC-10-175-20SP	1 3/4" 20 Spline PTO (For PTOC-1000-175-20SP)	1
9	5118124	BAC-10-S	1" Stub Drive Shaft (For PTOC-600-10B)	1
10	5055021	BAC-11	Locking Collar (For BAC-10-21SP Shaft)	1
11	5055022	BAC-11-175	Locking Collar (For BAC-10-175 Shaft)	1
12	5117178	BAC-11-1	Set Screw (For BAC-11-175 Locking Collar)	1
13	5084021	BAC-12	1 1/4" x 1" Volute	1
14	5023041	BAC-13	Idler Arm	1
15	5070011	BAC-14-MIA	Mounting Frame, Mach. For Idler Arm	1
16	5271422	BAC-15	Bearing Housing (For PTO Models)	1
	5271425	BAC15-B	Bearing Housing w/base (For PTOC-600-10B)	1
17	5159048	BAC-26-Valox	Impeller Valox, L. H. Thread	1
17	5159029	BAC-26-CI	Impeller Cast Iron, L. H. Thread (Optional)	1
19	5032020	BAC-28-8	Belt, 8 Groove (PTOC-600) (Obsolete)	1
19	5032022	BAC-28-10	Belt, 10 Groove (PTOC-600-10, & 10B)	1
19	5032025	BAC-28-10-M	Belt, 10 Groove (PTOC-1000-10)	1
20	5105022	BAC-29-10-1.5	Pully, 10 Groove	1
21	5105023	BAC-30-10	Pully, 10 Groove (PTOC-600-10, & 10B)	1
21	5105024	BAC-30-10-M	Pully, 10 Groove (PTOC-1000-10)	1
22	5031148	BAC-31-1	Ball Bearing, BAC-10 Drive Shaft (792 & up)	2
23	5110084	BAC-32	External Snap Ring	2
24	5127073	BAC-32-S	Spacer	1
25	5110085	BAC-33	Internal Snap Ring	2
26	5110086	BAC-34	Internal Snap Ring	2
27	5110087	BAC-35	External Snap Ring	1
28	5110088	BAC-36	External Snap Ring	1
29	5031060	BAC-37	Sealed Ball Bearing	2
30	5127155	BAC-38-1	Bearing Spacer, For BAC-10 Drive Shaft (792 & up)	1
31	5034099	40950	Hex Head Cap Screw	4
32	5117099	BAC-40	Slotted Set Screw	3
33	5006099	40960	Jam Nut	3
38	5006101	BAC-46	5/8" Spacer	1
39	5034084	BAC-47	Cap Screw	1
40	5110089	BAC-49	Retainer Ring	1
41	5089022	BAC-50	Key	1
42	5089023	BAC-51	Key	1
43	5049015	BAC-52	1/4" Cold Shut Chain Anchor	1
44	5102038	BAC-53	1/8" NPT Pipe Plug	3
45	5108028	BAC-54	Slinger	1
46	5031066	BAC-55	Idler Bearing And Roller Assembly	1
	5271428	BAC-55-A	Idler Arm Assembly	1
47	5117100	BAC-57	Set Screw	2
	5012009	BAC-58	Zerk Fitting	1
48	5034192	41250	Cap Screw	1
49	5006035	BAC-63	Self Locking Nut	1
50	5117101	41300	Set Screw	2
52	5108032	BAC-81-QC	Ball Retainer	1
53	5019144	BAC-82-QC	Spring For Quick Coupler	1
54	5026022	BAC-83-QC	Ball For Quick Coupler	3
	5076003	BGKB	Belt Guard Kit (PTOC-Pumps)	1

### PUMP MODELS

- PTOC-600-B
- PTOC-600-SP
- PTOC-600-6-SPQC
- PTOC-1000-21-SP
- PTOC-1000-175-20-SP

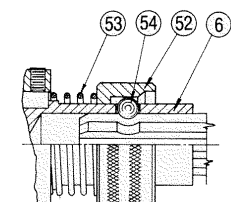
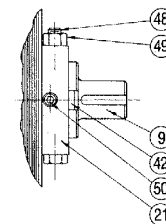
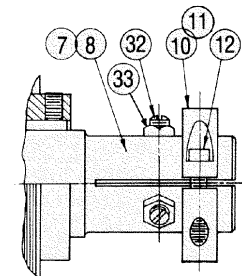
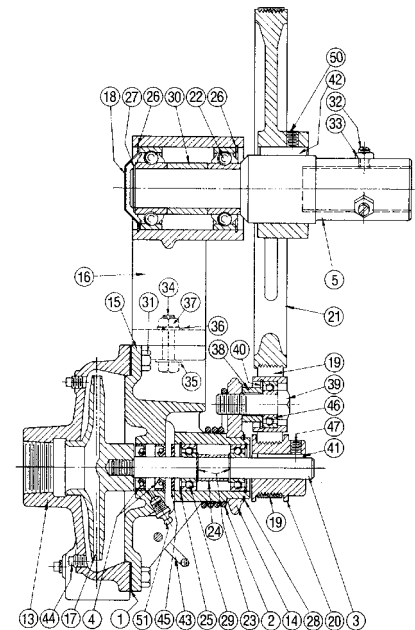

# DIAPHRAGM PUMPS & ENGINES

PISTON-DIAPHRAGM PUMPS are ideal for spraying agricultural spray for pest and weed control and liquid fertilizer application. The moving parts are stainless steel hermetically sealed in 100% oil bath and never come in contact with spray liquid. The only moving part of the pump in contact with the spray is the diaphragm which is resistant to most chemicals pumped.

Diaphragms and valves can be replaced on the farm without special tools and are easily accessible from the outside of the pumps. Pumps will run dry and with abrasives, they are positive displacement type pumps and self priming. They are light, and have surge chamber attached. Hose connectors are built on the pumps.



AR252-SP/SGC



AR503-SP

## MEDIUM PRESSURE DIAPHRAGM PUMPS

FIMCO Code #	Max GPM	Max PSI	Max RPM	Description
AR252-SP/SGC	6.5	362	650	2 - diaphragm pump - 3/4" HB inlet, 1/2" NPT outlet. AR252 3/4" solid keyed shaft
AR30-SP	9.6	580	550	2 - diaphragm pump - 1" HB inlet, 1/2" HB outlet.
AR503-SP	14.3	580	550	3 - diaphragm pump. 1 1/4" HB inlet, 3/4" NPT outlet. Select shaft kit or gearbox.
AR403-GR3/4-GCI	10.7	280	3600	3 - diaphragm pump w/ gearbox AR1636 & control GIC40 for mounting on 5 HP gas engine.

PLEASE CONTACT US FOR ANY SPECIAL ORDER AR PRODUCT REQUESTS

## HONDA REPLACEMENT ENGINES

MFG Part #	FIMCO Code #	HP	Starter	Crankshaft Size	Oil Alert
GX160K1HX2	5152080	163cc	Rewind	Gear Reduction	Yes
GX160K1QX2	5152058	163cc	Rewind	3/4" Keyway	Yes
GX240K1QAE2	5152090	270cc	Electric & Rewind	1" Keyway	Yes
GX240K1HA2	5152091	270cc	Rewind	Gear Reduction	Yes

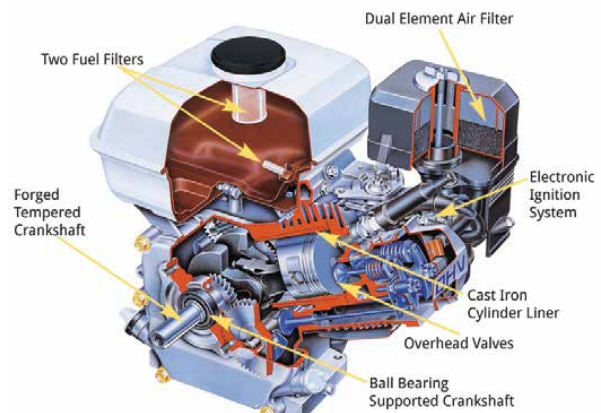

# POLYPROPYLENE & NYLON FITTINGS

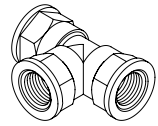

Female National Pipe Thread Tee

Description	POLYPROPYLENE		NYLON	
	FIMCO Code #	MFG Part #	FIMCO Code #	MFG Part #
1/4"	5010229	3TT14	5010154	TT14
1/2"	5010230	3TT12	5010113	TT12
3/4"	5010231	3TT34	5010089	TT34
1"	5010232	3TT100	5010130	TT100
1-1/4"	5010233	3TT114	5010131	TT114
1-1/2"	5010234	3TT112	5010132	TT112
2"	5010235	3TT200	5010133	TT200
3"	TEE300	TEE300		

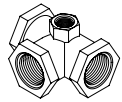

Female National Pipe Thread Tee With 1/4" Gauge Port

1/2"	5010256	3GTT1214	5010193	GTT1214
3/4"	5010257	3GTT3414	5010135	GTT3414

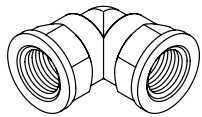

Female National Pipe Thread 90° Elbow

1/2"	5010236	3LL12	5010176	LL12
3/4"	5010237	3LL34	5010177	LL34
1"	5010238	3LL100	5010178	LL100
1-1/4"	5010239	3LL114	5010179	LL114
1-1/2"	5010240	3LL112	5010180	LL112
2"	5010241	3LL200	5010181	LL200
3"	5010260	EL300-90		

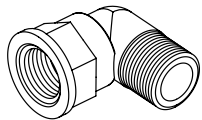

90° Street Elbow

1/4"	5010242	3SE14	5010137	SE14
3/8"	5010435	3SE38	5010343	SE38
1/2"	5010243	3SE12	5010148	SE12
3/4"	5010244	3SE34	5010144	SE34
3/4" - 45°	5010249	3SE3445	5010192	SE3445
1"	5010245	3SE100	5010146	SE100
1-1/4"	5010246	3SE114	5010147	SE114
1-1/2"	5010247	3SE112	5010149	SE112
2"	5010248	3SE200	5010145	SE200

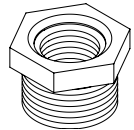

Hexagon Head Bushing MNPT x FNPT

3/8" x 1/4"	5041072	3RB3814	5041039	RB3814
1/2" x 1/4"	5041073	3RB1214	5041055	RB1214
1/2" x 3/8"	5041074	3RB1238	5041038	RB1238
3/4" x 1/8"	5041075	3RB3418	5041044	RB3418
3/4" x 1/4"	5041076	3RB3414	5041043	RB3414
3/4" x 3/8"	5041077	3RB3438	5041056	RB3438
3/4" x 1/2"	5041078	3RB3412	5041020	RB3412
1" x 1/2"	5041079	3RB10012	5041059	RB10012
1" x 3/4"	5041080	3RB10034	5041034	RB10034
1-1/4" x 3/4"	5041081	3RB11434	5041051	RB11434
1-1/4" x 1"	5041082	3RB114100	5041033	RB114100
1-1/2" x 1-1/4"	5041083	3RB112114	5041035	RB112114
2" x 1-1/4"	5041085	3RB200114	5041057	RB200114
2" x 1"	5041084	3RB200100	5041058	RB200100
2" x 1-1/2"	5041086	3RB200112	5041037	RB200112
3" x 1-1/2"	5041090	RB-300-150	5041052	RB300200
3" x 2"	5041087	3RB300200		

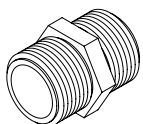



Pipe Nipples

1/4" x Close	5011137	3M14	5011110	M14
3/8" x Close	5011138	3M38	5011111	M38
1/2" x Close	5011139	3M12	5011054	M12
3/4" x Close	5011140	3M34	5011055	M34
1" x Close	5011141	3M100	5011095	M100
1-1/4" x Close	5011142	3M114	5011103	M114
1-1/2" x Close	5011143	3M112	5011104	M112

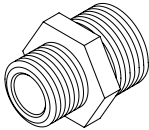
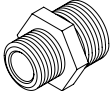
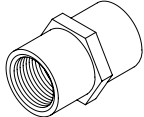
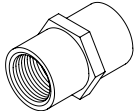
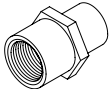
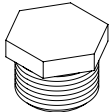

# POLYPROPYLENE & NYLON FITTINGS

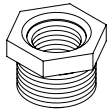
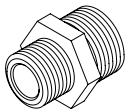
		POLYPROPYLENE		NYLON		
		Description	FIMCO Code #	MFG Part #	FIMCO Code #	MFG Part #
 <p>Pipe Nipples</p>	1-1/2" x 4"	5011149	NIP150-4			
	1-1/2" x 6"	5011150	NIP150-6			
	2" x Close	5011144	3M200	5011105	M200	
	2" x 4"	5011151	NIP200-4			
	2" x 6"	5011152	NIP200-6			
	3" x Short	5011148	NIP300-SH			
	3" x 4"	5011153	NIP300-4			
	3" x 6"	5011154	NIP300-6			
 <p>Reducing Pipe Nipples</p>	1/2" x 3/8"	5011145	3M1238	5011128	M1238	
	3/4" x 3/8"	5011146	3M3438	5011114	M3438	
	3/4" x 1/2"	5011147	3M3412	5011129	M3412	
 <p>Pipe Couplings FNPT x FNPT</p>	1/2"	5010250	3FC12	5010182	FC12	
	3/4"	5010251	3FC34	5010183	FC34	
	1"	5010252	3FC100	5010184	FC100	
	1-1/4"	5010253	3FC114	5010185	FC114	
	1-1/2"	5010254	3FC112	5010186	FC112	
	2"	5010255	3FC200	5010187	FC200	
	3"	5010259	CPLG300			
 <p>Reducing Pipe Couplings FNPT x FNPT</p>	1-1/2" x 1"	5010262	RC150-100			
	1-1/2" x 1-1/4"	5010263	RC150-125			
	2" x 1"	5010264	RC200-100			
	2" x 1-1/4"	5010265	RC200-125			
	2" x 1-1/2"	5010266	RC200-150			
 <p>Coupling FGHT x FNPT</p>	3/4 FGHT x 1/2" FNPT (Reducing Coupling)	5005190	3J3412	5005170	J3412	
 <p>Pipe Plug</p>	1/8"	5102067	3F18	5102049	F18	
	1/4"	5102068	3F14	5102022	F14	
	3/8"	5102069	3F38	5102023	F38	
	1/2"	5102070	3F12	5102024	F12	
	3/4"	5102071	3F34	5102025	F34	
	1"	5102072	3F100	5102026	F100	
	1-1/4"	5102073	3F114	5102027	F114	
	1-1/2"	5102075	3F112	5102085	F112	
	2"	5102074	3F200	5102054	F200	
	3"	5102076	PLUG300			
 <p>Pipe Cap</p>	1-1/2"	5046127	CAP150			
	2"	5046128	CAP200			
	3"	5046129	CAP300			
 <p>Male x Female Adapter</p>	1/2" FNPT x 3/4" MGHT Adapter	5005191	3G3412	5005023	GFA128	
	3/4" FNPT x 3/4" MGHT Adapter	5005192	3G34	5005024	G34	
	3/4" FGHT x 3/4" MNPT Adapter	5005193	3H34			
 <p>Male x Male Adapter</p>	3/8" MNPT x 3/4" MGHT Adapter	5005194	3E3438	5005020	E3438	
	1/2" MNPT x 3/4" MGHT Adapter	5005195	3E3412	5005021	E3412	
	3/4" MNPT x 3/4" MGHT Adapter	5005196	3E34	5005022	E34	

# POLYPROPYLENE & NYLON FITTINGS

## POLYPROPYLENE

## NYLON

Description	FIMCO Code #	MFG Part #	FIMCO Code #	MFG Part #
3" x 3"	5067153	HB300		
2" x 2"	5067110	3A200	5067036	A200
1 - 1/2" x 1 - 1/2"	5067111	3A112	5067010	A112
1 - 1/2" x 1 - 1/4"	5067112	3A112114	5067095	A112114
1 - 1/4" x 1 - 1/2"	5067113	3A114112	5067093	A114112
1 - 1/4" x 1 - 1/4"	5067114	3A114	5067009	A114
1 - 1/4" x 1"	5067115	3A114100	5067072	A114100
1 - 1/4" x 3/4"	5067116	3A11434	5067094	A11434
1" x 1 1/4"	5067117	3A100114	5067008	A100114
1" x 1"	5067118	3A100	5067007	A100
1" x 3/4"	5067119	3A10034	5067086	A10034
3/4" x 3/8"	5067124	3A3438	5067011	A3438
3/4" x 1/2"	5067125	3A3412	5067012	A3412
3/4" x 5/8"	5067126	3A3458	5067013	A3458
3/4" x 3/4"	5067127	3A34	5010020	A34
3/4" x 1"	5067128	3A34100	5067014	A34100
1/2" x 1/4"	5067129	3A1214	5067015	A1214
1/2" x 3/8"	5067130	3A1238	5067016	A1238
1/2" x 1/2"	5067131	3A12	5067017	A12
1/2" x 5/8"	5067132	3A1258	5067018	A1258
1/2" x 3/4"	5067133	3A1234	5067019	A1234
3/8" x 1/4"	5067134	3A3814	5067020	A3814
3/8" x 3/8"	5067135	3A38	5010021	A38
3/8" x 1/2"	5067136	3A3812	5067021	A3812
1/4" x 1/4"	5067137	3A14	5067022	A14
1/4" x 3/8"	5067138	3A1438	5067005	A1438
1/4" x 1/2"	5067139	3A1412	5067023	A1412
1/8" x 1/4"	5067140	3A1814	5067024	A1814
1/8" x 3/8"	5067141	3A1838	5067035	A1838

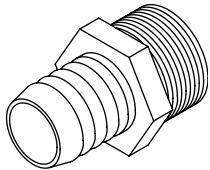

Male National Pipe Thread x Hose Barb

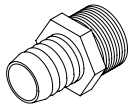

Male Garden Hose Thread x Hose Barb

3/4" x 3/8"	5067120	3D3438	5067025	D3438
3/4" x 1/2"	5067121	3D3412	5067026	D3412
3/4" x 5/8"	5067122	3D3458	5067027	D3458
3/4" x 3/4"	5067123	3D34	5067028	D34

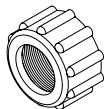

Swivel Nuts For Barbs Below

3/4" FGHT	5006209	3B34	5006055	B34
3/4" FNPT	5006210	3B35	5006056	B35

\* Can Only Be Used With No. 5149038 1" Swivel Barb Below

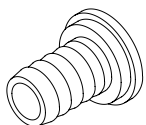

Swivel Barbs For Nuts Above

1/4" Swivel Barb	5149033	3C14	5149031	C14
3/8" Swivel Barb	5149034	3C38	5149010	C38
1/2" Swivel Barb	5149035	3C12	5149011	C12
5/8" Swivel Barb	5149036	3C58	5149012	C58
3/4" Swivel Barb	5149037	3C34	5149013	C34
* 1" Swivel Barb	5149038	3C100	5149030	C100

\* Can Only Be Used With No. 5006211 1" Swivel Nut Above



Swivel Nut Gaskets

3/4" Barb Washer (G. H. Washer)	5016066	8330010		
1" Barb Washer	5016130	W405P		

# POLYPROPYLENE & NYLON FITTINGS

## POLYPROPYLENE

## NYLON

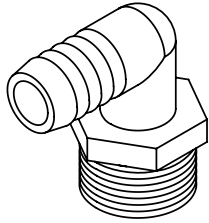

Male National Pipe Thread x Hose Barb 90° Elbow

Description MNPT x Hose Barb	FIMCO Code #	MFG Part #	FIMCO Code #	MFG Part #
1/4" x 1/2"	5010197	3EL1412	5010047	EL1412
1/4" x 3/8"	5010198	3EL1438	5010046	EL1438
1/4" x 5/8"			5010157	EL1458
3/8" x 1/4"	5010199	3EL3814	5010158	EL3814
3/8" x 3/8"	5010200	3EL38	5010042	EL38
3/8" x 1/2"	5010201	3EL3812	5010043	EL3812
3/8" x 3/4"			5010161	TLS63
1/2" x 3/8"	5010202	3EL1238	5010038	EL1238
1/2" x 1/2"	5010203	3EL12	5010039	ESSL12
1/2" x 5/8"	5010204	3EL1258	5010040	EL1258
1/2" x 3/4"	5010205	3EL1234	5010152	EL1234
3/4" x 3/8"	5010206	3EL3438	5010035	EL3438
3/4" x 1/2"	5010207	3EL3412	5010036	EL3412
3/4" x 5/8"	5010208	3EL3458	5010037	EL3458
3/4" x 3/4"	5010209	3EL34	5010028	EL34
3/4" x 1"	5010210	3EL34100	5010034	EL34100
1" x 1/2"	5010211	3EL10012	5010153	EL10012
1" x 3/4"	5010212	3EL10034	5010032	EL10034
1" x 1"	5010213	3EL100	5010033	EL100
1-1/4" x 3/4"	5010214	3EL11434	5010159	EL11434
1-1/4" x 1"	5010215	3EL114100	5010151	EL114100
1-1/4" x 1-1/4"	5010216	3EL114	5010100	EL114
1-1/4" x 1-1/2"	5010217	3EL114112	5010160	EL114112
1-1/2" x 1-1/2"	5010218	3EL112	5010143	EL112
2" x 2"	5010219	3EL200	5010150	EL200



Female National Pipe Thread x Hose Barb 90° Elbow

3/4" x 1/2"	5010220	3EL3412F	5010114	EL3412F
3/4" x 3/4"	5010221	3EL34F	5010136	EL34F

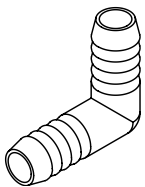

Hose Barb x Hose Barb 90° Elbow

1/4" x 1/4"			5010167	EL14HB
3/8" x 3/8"	5010222	3EL38HB	5010168	EL38HB
1/2" x 1/2"	5010223	3EL12HB	5010170	EL12HB
3/4" x 3/4"	5010224	3EL34HB	5010171	EL34HB
1" x 1"			5010172	EL100HB
1-1/4" x 1-1/4"			5010173	EL114HB
1-1/2" x 1-1/2"			5010174	EL112HB
2" x 2"			5010175	EL200HB

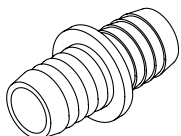

Hose Mender

1/4"	5067142	3SHM14	5067074	SHM14
3/8"	5067143	3SHM38	5067029	SHM38
1/2"	5067144	3SHM12	5067030	SHM12
5/8"	5067145	3SHM58	5067077	SHM58
3/4"	5067146	3SHM34	5067031	SHM34
1"	5067147	3SHM100	5067032	SHM100
1-1/4"	5067148	3SHM114	5067084	SHM114
1-1/2"	5067149	3SHM112	5067085	SHM112
2"	5067150	3SHM200	5067097	SHM200

# POLYPROPYLENE & NYLON FITTINGS

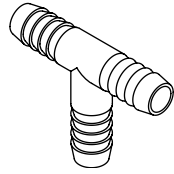

Hose Barb Tee

Description Hose Barb Size	POLYPROPYLENE		NYLON	
	FIMCO Code #	MFG Part #	FIMCO Code #	MFG Part #
1/4" x 1/4" x 1/4"	5086024	3T14	5086013	T14
3/8" x 3/8" x 3/8"	5086025	3T38	5086002	T38
1/2" x 1/2" x 1/2"	5086026	3T12	5086003	T12
1/2" x 1/2" x 3/8"	5086027	3T3812	5086016	T3812
1/2" x 1/2" x 3/4"	5086028	3T3412	5086017	T3412
5/8" x 5/8" x 5/8"	5086029	3T58	5086008	T58
3/4" x 3/4" x 3/4"	5086030	3T34	5086004	T34
1" x 1" x 1"	5086031	3T100	5086005	T100
1-1/4" x 1-1/4" x 1-1/4"	5086032	3T114	5086007	T114
1-1/2" x 1-1/2" x 1-1/2"	5086033	3T112	5086014	T112
2" x 2" x 2"	5086034	3T200	5086018	T200

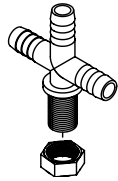

Hose Barb Nozzle  
Body Cross

3-3/8" Hose Barb.	5056092	3T38C	5272127	T38C
3-1/2" Hose Barb.	5056093	3T12C	5271920	T12C



Hose Barb Nozzle  
Body Elbow

Fits 3/8" Hose	5056094	3NTL38	5056024	NTL38
Fits 1/2" Hose	5056095	3NTL12	5056023	NTL12
Fits 5/8" Hose	5056096	3NTL58	5056061	NTL58
Fits 3/4" Hose	5056097	3NTL34	5056057	NTL34



Hose Barb Nozzle  
Body Tee

Fits 3/8" Hose	5056098	3NTT38	5056028	NTT38
Fits 1/2" Hose	5056099	3NTT12	5056027	NTT12
Fits 5/8" Hose	5056100	3NTT58	5056062	NTT58
Fits 3/4" Hose	5056101	3NTT34	5056056	NTT34

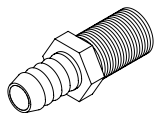

Hose Barb Nozzle  
Body Straight

5002246 8400-T-406-NYB

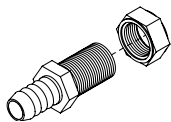

Hose Barb Nozzle  
Long Shank Body  
w/Locknut - Straight

3/8" H.B.	5002396	338D		
1/2" H.B.	5002397	33812D	5002359	3812D

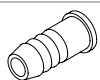

Swivel Barb  
(Fits Nozzle Cap)

3/8" H.B.	5149039	3K8438	5149019	K8438
1/2" H.B.	5149040	3K8412	5149014	K8412

# HOSE INSERTS & NYLON QUICK COUPLERS

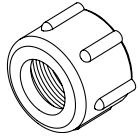

Nozzle Cap  
(Swivel Nut)

Description	POLYPROPYLENE		NYLON	
	FIMCO Code #	MFG Part #	FIMCO Code #	MFG Part #
Nozzle Cap	5046126	38027	5046052	8027
Blank Nozzle Cap	5046131	33942	5046130	3942



Nozzle Cap  
Thread Locknut

Description	FIMCO Code #	MFG Part #	FIMCO Code #	MFG Part #
Lock Nut, NPS	5006212	3B12	5006184	B12

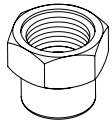

Adapter Nozzle Cap  
Thread x 1/4" FNPT

Description	FIMCO Code #	MFG Part #	FIMCO Code #	MFG Part #
Adapter			5005137	4676-NYB-1/4

## NYLON QUICK COUPLER FOR HOSE

Hose savers are a three piece assembly - hose barb, fly nut and nipple - that allows you to disconnect hose from your pump without cutting or removing the hose.

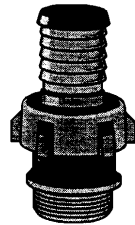

Hose Saver  
Straight Assembly

MNPT	Description	FIMCO Code #	MFG Part #
3/4"	3/4"	5149053	626320N
1"	1"	5149056	626425N
1 - 1/2"	1 - 1/2"	5149062	626638N



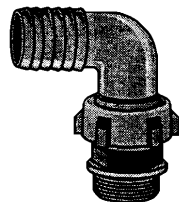





- Nylon material safe for most ag chemicals
- 150 PSI Rating
- Sizes, 3/4" Thru 2"



Hose Saver  
Elbow Assembly

MNPT	Description	FIMCO Code #	MFG Part #
3/4"	3/4"	5149065	627320N
3/4"	1"	5149066	627325N
1"	1"	5149068	627425N
1 - 1/4"	1 - 1/4"	5149071	627532N
2"	2"	5149076	627751N

# POLYPROPYLENE QUICK COUPLERS FOR HOSES

		BANJO POLYPROPYLENE		NORWESCO POLYPROPYLENE		
		Description	FIMCO Code #	MFG Part #	FIMCO Code #	MFG Part #
 A / Male Adapter Female Thread	3/4"	5005156	75A3/4	5005260	61207	
	1"	5005138	100A	5005261	61215	
	1-1/4"	5005157	125A	5005262	61223	
	1-1/2"	5005139	150A	5005263	61231	
	2"	5005140	200A	5005264	61239	
	3"	5005153	300A	5005265	61247	
	4"	5005253	400A	5005254	62789	
 F / Male Adapter Male Thread	3/4"	5005158	075F	5005266	61212	
	1"	5005141	100F	5005267	61220	
	1-1/4"	5005159	125F	5005268	61228	
	1-1/2"	5005142	150F	5005269	61236	
	2"	5005143	200F	5005270	61244	
	3"	5005154	300F	5005271	61252	
	4"	5005255	400F	5005256	62794	
 E / Male Adapter Hose Shank	3/4"	5005160	075E	5005272	61211	
	1"	5005144	100E	5005273	61219	
	1-1/4"	5005161	125E	5005274	61227	
	1-1/2"	5005145	150E	5005275	61235	
	2"	5005146	200E	5005276	61243	
	3"	5005155	300E	5005277	61251	
	4"	5005257	400E	5005258	62793	
 D / Female Coupler Female Thread	3/4"	5057107	075D	5057180	61261	
	1"	5057092	100D	5057181	61265	
	1-1/4"	5057108	125D	5057182	61269	
	1-1/2"	5057093	150D	5057183	61273	
	2"	5057094	200D	5057184	61277	
	3"	5057102	300D	5057185	61281	
	4"	BJ400D	400D	5057201	62792	
 B / Female Coupler Male Thread	3/4"	5057109	75B3/4	5057186	61259	
	1"	5057095	100B	5057187	61263	
	1-1/4"	5057110	125B	5057188	61267	
	1-1/2"	5057096	150B	5057189	61271	
	2"	5057097	200B	5057190	61275	
	3"	5057103	300B	5057191	61279	
	4"	5057202	400B	5057203	62790	
 C / Female Coupler Hose Shank	3/4"	5057111	075C	5057192	61260	
	1"	5057098	100C	5057193	61264	
	1-1/4"	5057112	125C	5057194	61268	
	1-1/2"	5057099	150C	5057195	61272	
	2"	5057100	200C	5057196	61276	
	3"	5057104	300C	5057197	61280	
	4"	5057204	400C	5057205	62791	
 PL / Plug For Female Coupler	3/4"	5102048	75PL	5120110	61214	
	1"	5102044	100125PL	5120111	61222	
	1-1/4"	5102044	100125PL	5120112	61238	
	1-1/2"	5102045	150PL	5120112	61238	
	2"	5102046	200PL	5120114	61246	
	3"	5102047	300PL	5120115	61254	
	4"	5102119	400PL	5102120	62796	
 CAP / Cap For Male Adapter	3/4"	5046090	075CAP	5046350	61258	
	1"	5046077	100125CAP	5046351	61266	
	1-1/4"	5046077	100125CAP	5046352	61274	
	1-1/2"	5046078	150CAP	5046352	61274	
	2"	5046079	200CAP	5046354	61278	
	3"	5046083	300CAP	5046355	61282	
	4"	5046371	400CAP	5046372	62795	
 Gasket For Couplers	3/4"	5072277	75G	5072482	61570	
	1"	5072214	100G	5072483	61571	
	1-1/4"	5072214	100G	5072484	61572	
	1-1/2"	5072215	150G	5072484	61572	
	2"	5072216	200G	5072486	61574	
	3"	5072278	300G	5072487	61575	
	4"	5072504	400G	5072505	62797	

# SPRAYER HOSE, CLAMPS & CUTTER

## HOSE

I.D. Size	# of Braids	Working Pressure	BULK ROLL		BOXED LENGTHS	
			FIMCO Code #	Feet On Roll	FIMCO Code #	Feet Per Box
3/8	1	150	5153076	*	5550001	100
3/8	2	250	5153077	*	5550002	100
1/2	1	150	5153079	*	5550003	100
1/2	2	250	5153080	*	5550004	100
5/8	1	150	5153082	*	5550005	100
3/4	1	150	5153084	*	5550007	100
3/4	2	250	5153085	*	5550008	100
1	2	150	5153087	*	5550010	100
1-1/4	2	150	5153088	**	5550011	50
					5550012	50



Note: 1 Braid = 2 Spiral Braid  
2 Braid = 4 Spiral Braid

Note: Full Rolls vary \*600 ft. to 700 ft. - \*\*300 ft. to 400 ft.

I.D. Size	Working Pressure	FIMCO Code #	Feet On Roll
3/8	275	5153113	300
1/2	275	5153114	300
3/4	250	5153115	200

### PVC CLEAR REINFORCED VINYL TUBING

\*Sold Only In Full Rolls



I.D. Size	Working Pressure	FIMCO Code #	Feet On Roll
1-1/2	Open Discharge	5153121	300
2	Open Discharge	5153120	100
2	Open Discharge	5153098	300

### PVC LAY FLAT DISCHARGE HOSE

\*Sold Only In 100' & 300' Rolls



### STAINLESS STEEL WORM DRIVEN HOSE CLAMPS



FIMCO Code #	MFG Part #	Fits Hose (Inside Diameter)
5051020	6202062	1/8" to 1/4"
5051021	5206052	3/8" to 1/2"
5051022	5208052	1/2" to 5/8"
5051023	5210052	5/8" to 3/4"
5051024	5212052	3/4" to 1"
5051025	5216052	1" to 1-1/4"
5051026	5224052	1-1/4" to 1-1/2"
5051027	5228052	1-1/2" to 2"
5051037	5236052	2" to 2-5/8"

### HOSE & PIPE CUTTER



Cuts: Polyethylene - Polybutylene  
PVC - ABS - Rubber hose

- Fast - Clean - Safe - Small - Light
- Strong tough nylon handles
- Replaceable stainless steel blades



CLEAN  
SMOOTH  
CUT

FIMCO Code #	Description
5271981	Li'l Nipper Hose Cutter (Cuts up to 1-1/4" ID Hose)
5273224	Li'l Nipper Hose Cutter (Cuts up to 2" ID Hose)

# PRESSURE GAUGES



1/4" Back Fitting

High Pressure, Plastic Case, Dry Gauge



1/4" Bottom Fitting  
Chemical Or Ammonia Gauges

WARNING: BRASS STEM GAUGES ARE NOT TO BE USED WITH AMMONIA



1/4" Bottom Fitting

High Pressure, Stainless Steel Case, Glycerin Filled, Chemical Gauges

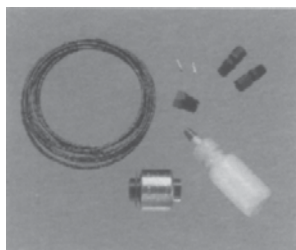

FIMCO Code #	MFG Part #	PSI Range
1/4" MIPT - Plastic Stem - 2" Face Back Mount		
5167097	-	0-100 PSI
1/4" MIPT - Plastic Stem - 2" Face		
5167006	SG602	0-60 PSI
5167007	SG1002	0-100 PSI
5167004	SG2002	0-200 PSI
5167005	L20	0-400 PSI
1/4" MIPT - Brass Stem - 2 1/2" Face		
5167017	SG60	0-60 PSI
5167018	SG100	0-100 PSI
5167019	SG200	0-200 PSI
5167066	SG400	0-400 PSI
1/4" MIPT - Brass Stem - 4" Face		
5167022	SG1004	0-100 PSI
5167033	SG2004	0-200 PSI
1/4" MIPT - Ammonia Gauge - 2 1/2" Face		
5167011	ASG60	0-60 PSI
5167010	ASG160	0-160 PSI
1/4" MIPT - Liquid Filled - Stainless Steel Case - 2-1/2" Face		
5167031	CG100	0-100 PSI
5167080	CG200	0-200 PSI
5167034	CG400	0-400 PSI
5167029	CG600	0-600 PSI
5167030	GG1000	0-1000 PSI
5167015	GG1500	0-1500 PSI
*5167027	GG2000	0-2000 PSI
*5167028	GG3000	0-3000 PSI
* Discontinued—Available only until present stock depleted.		
1/4" MIPT - Liquid Filled - Stainless Steel Case - 2-1/2" Face - Back Mount		
5167108	5167108	0-100 PSI

Accessories For Gauges		
5273051	23800A-1/8	Isolator Kit 1/8"
5273294	23800A-1/4	Isolator Kit 1/4"



# VALVES

std = standard port fp = full port



**POLY BOLTED BALL VALVE STAINLESS STEEL BOLTS, NUTS & WASHERS**

FIMCO Code #	MFG Part #	Size
5143361	60540	1/2" fp
5143362	60541	3/4" fp
5143363	60542	1" std
5143364	60543	1" fp
5143365	61734	1-1/4" std
5143366	60527	1-1/4" fp
5143367	60526	1-1/2" fp
5143368	60529	2" std
5143369	60528	2" fp
5143370	61720	3" fp
5143396	62787	4" fp

**POLY BOLTED BALL VALVE WITH MALE NIPPLE**



5143371	62046	2" std
5143372	61876	2" fp
5143373	62047	3" fp

**ANGLE VALVE**



5143374	60544	1-1/2" fp
5143375	60545	2" std
5143376	60546	2" fp

**SINGLE UNION BALL VALVE**



5143205	60409	1/2"
5143206	60410	3/4"
5143207	60411	1"
5143208	60412	1-1/4"
5143209	60413	1-1/2"
5143210	60414	2"
5143377	60415	3"
5143378	60479	1"/45° Nozzle Valve

**MULTI-PORT BALL VALVE**



5143379	60417	3/4" True Union
5143380	60418	2" Multi-Port

**POLY COMPACT BALL VALVE STAINLESS STEEL BOLTS, NUTS & WASHERS**



5143381	62286	2" fp/mpt x fpt
5143382	62287	2" fp/fpt x fpt
5143383	62288	2" fp/mpt x male Coupler
5143384	62314	2" fp/fpt x male Coupler



# VALVES & GARDEN HOSE FITTINGS

## CELCON GLOBE VALVE - FIPT



FIMCO Code #	MFG Part #	Size
5143107	SCL-0500T	1/2"
5143123	SCL-0750T	3/4"
5143220	V075	3/4"
5143144	V100	1"
5143173	V125	1-1/4"
5143142	V150	1-1/2"
5143143	V200	2"
5143161	V300	3"
5143312	V100FP	1"
5143222	V200FP	2"
5143223	V300FP	3"
5143211	101-302	3/8"
5143197	101-303	1/2"
5143190	101-304	3/4"
5143191	101-305	1"

## POLY BALL VALVE



## FULL PORT POLY BALL VALVE



## BRASS BALL VALVE



## GARDEN HOSE FITTINGS



Part #	Description	Part #	Description
GHFT075A	3/4" Male QDC X 3/4" FGHT	GHFT075MPT	3/4" MPT X 3/4" FGHT
GHMT075B	3/4" Female QDC X 3/4" MGHT	GHMT075FPT	3/4" FPT X 3/4" MGHT
GHFT075D	3/4" Female QDC X 3/4" FGHT	GHMT075MPT	3/4" MPT X 3/4" MGHT
GHMT075F	3/4" Male QDC X 3/4" MGHT	GHN075	3/4" Garden Hose Spray Nozzle

## HOSE BARB

MALE GARDEN HOSE BY HOSE BARB

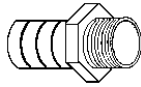

Part #	MPT	HB
NYGHB3414	3/4	1/4
3D3438	3/4	3/8
3D3412	3/4	1/2
3D3458	3/4	5/8
3D34	3/4	3/4

## ELBOW

MALE GARDEN HOSE BY HOSE BARB 90°



Part #	MPT	HB
NYGHB3414EL	3/4	1/4
NYGHB3438EL	3/4	3/8
NYGHB3412EL	3/4	1/2
NYGHB3458EL	3/4	5/8
NYGHB34EL	3/4	3/4

## COUPLING

GARDEN HOSE BARB BY HOSE BARB



Part #	GHB	HB
NYGHC3414	3/4	1/4
NYGHC3438	3/4	3/8
NYGHC3412	3/4	1/2
NYGHC3458	3/4	5/8
NYGHC34	3/4	3/4

## NIPPLE

MALE GARDEN HOSE THREAD X MALE PIPE THREAD



Part #	MPT	MGHT
3E3438	3/4	3/8
3E3412	3/4	1/2
3E+34	3/4	3/4

## NIPPLE

MALE GARDEN HOSE THREAD



Part #	MGHT	MGHT
NYGN34	3/4	3/4

## ADAPTOR

MALE GARDEN HOSE THREAD X FPT



Part #	MGHT	FPT
3G3414	3/4	1/4
3G3412	3/4	1/2
3G34	3/4	3/4

## ADAPTOR

FEMALE GARDEN HOSE BY MALE PIPE THREAD



Part #	FGHT	MPT
3H34	3/4	3/4

## ADAPTOR

FEMALE GARDEN HOSE BY MALE GARDEN HOSE



Part #	FGHT	MGHT
3I34	3/4	3/4

## COUPLER

FEMALE GARDEN HOSE BY FEMALE PIPE THREAD



Part #	FGHT	FPT
3J3412	3/4	1/2

## GARDEN HOSE CAP

FEMALE GARDEN HOSE CAP



Part #	FGHT
3N34	3/4

## FLAT SEAT HOSE BARB

Part #	Barb
3C14	1/4
3C38	3/8
3C12	1/2
3C58	5/8
3C34	3/4
3C100	1



All flat seat hose barbs must use a B34 or a B35 swivel nut.

## GARDEN HOSE

SWIVEL NUT use with flat seat hose barbs



Part #	Pipe Thread
3B34	3/4 FGHT
3B35	3/4 FPT

## GARDEN HOSE WASHER & FILTER WASHER



Part #	Pipe Thread
W406Y	Washer
W160M	Filter Washer

# LINE STRAINERS

## AA126 FLUSH-OUT LINE STRAINER



MFG Part #	Description
AA126ML-3-30	3/4" Strainer w/30 Mesh
AA126ML-3-50	3/4" Strainer w/50 Mesh
AA126ML-3-80	3/4" Strainer w/80 Mesh
AA126ML-4-30	1" Strainer w/30 Mesh
AA126ML-4-50	1" Strainer w/50 Mesh
AA126ML-5-30	1-1/4" Strainer w/30 Mesh
AA126ML-5-50	1-1/4" Strainer w/50 Mesh
AA126ML-6-30	1-1/2" Strainer w/30 Mesh

- 200 PSI (14 bar) max pressure rating
- Strainer head and bowl are made of glass-filled polypropylene with EPDM gasket
- Removable cap and gasket for flush-out or self-cleaning operations.
- Screens are made of 304SS with color-coded polypropylene frame and are removable for cleaning
- Integral mounting provision allows the strainer to be attached to machine using M10 or 3/8" diameter bolts
- Available with 3/4", 1" NPT or BSPT (F) threads and 50 or 75 series flange fitting connections or easy assembly
- Uses same screen as the AA124 line strainer

## NYLON LINE STRAINER 3/4" - 1" - 1-1/4" & 1-1/2"



Complete Strainers	FIMCO Code #	MFG Part #	Description
	5116236	AA126ML-4-50	1" Nylon Strainer w/50 mesh Screen
Gaskets	5072245	CP7717-2/226-VI	Bowl Gasket, Viton for 3/4" & 1"
	5072221	CP12291-VI	Bowl Gasket, Viton for 1 1/4" & 1 1/2"
Screens	5116192	CP16903-3-SSPP	30 Mesh Screen for 3/4" & 1" Strainer
	5116193	CP16903-4-SSPP	50 Mesh Screen for 3/4" & 1" Strainer
	5116186	CP15941-2-SSPP	30 Mesh Screen for 1 1/4" & 1 1/2" Strainer
	5116187	CP15941-3-SSPP	50 Mesh Screen for 1 1/4" & 1 1/2" Strainer
Bowls	5058098	CP15403-NY	Bowl, Nylon for 3/4" & 1" Strainer
	5058099	CP12288-NY	Bowl, Nylon for 1 1/4" & 1 1/2" Strainer

- Easy Maintenance
- No tools required
- Reinforced Nylon bowls removed by hand for quick, efficient screen cleaning
- For operating pressures up to 75 p.s.i.

\*\*\*LIMITED TO CURRENT INVENTORY. REPLACED BY AA126 SERIES\*\*\*

## 2" POLYPROPYLENE STRAINER



Complete Strainers	FIMCO Code #	MFG Part #	Description
	5116206	LS200-20	2" x 2" Line Strainer w/20 Mesh Screen
	5116207	LS200-50	2" x 2" Line Strainer w/50 Mesh Screen
	5116208	LS200-80	2" x 2" Line Strainer w/80 Mesh Screen
	5116209	LS220	20 mesh screen only
Screens	5116210	LS250	50 mesh screen only
	5116211	LS280	80 mesh screen only
Gaskets	5072295	LS200-G	Gasket

- Precision molded construction
- Corrosion resistant
- Light weight
- Fiberglass reinforced
- Easy grip end cap
- Stainless steel screen
- EPDM gasket
- Heavy duty end cap threads



# LINE STRAINERS

## NYLON LINE STRAINER

1/2" MNPT



FIMCO Code #	Description
5116417	Inline Strainer, 1/2" MNPT, 50 Mesh, Clear Bowl
5046451	1/2" Inline Strainer Poly Cap
5058205	1/2" NTP Inline Strainer Clear Bowl
5072533	1/2" NTP Inline Strainer O-Ring
5116452	1/2" NPT Inline Strainer Screen

## NYLON LINE STRAINER

3/4" & 1"

- Made of corrosion resistant nylon.
- Easily installed into plumbing systems.
- Simply unscrew bowl for easy cleaning.



	FIMCO Code #	Description
Complete Strainers	5116179	3/4" Nylon Strainer w/40 mesh screen
	5116322	3/4" Short Bowl Nylon Strainer/40 Mesh Screen
	5116182	1" Nylon Strainer w/40 mesh screen
Gaskets	5072228	Viton gasket
	5072229	EPDM gasket
Screens	5116180	40 mesh screen only
	5116323	40 mesh screen only For Short Bowl Strainer
	5116181	80 mesh screen only
Bowls	5058075	Bowl for 3/4" & 1" strainer

## NYLON LINE STRAINERS

1/2" - 3/4" - 1" - 1-1/4"

150 P.S.I. Maximum

**HYPRO®**



	FIMCO Code #	MFG Part #	Description
Complete Strainers	5117129	3350-0046	1/2" Strainer w/50 mesh screen
	5117130	3350-0043	1/2" Strainer w/80 mesh screen
	5116136	3350-0034	3/4" Strainer w/50 mesh screen
	5116141	3350-0035	3/4" Strainer w/80 mesh screen
	5116161	3350-0057	1" Strainer w/20 mesh screen
	5116162	3350-0058	1" Strainer w/50 mesh screen
	5116163	3350-0059	1" Strainer w/80 mesh screen
	5116243	3350-0071	1 1/4" Strainer w/20 mesh screen
	5116244	3350-0072	1 1/4" Strainer w/50 mesh screen
Gaskets	5072149	1700-0044	Buna-N Gasket for 1/2" & 3/4" Strainer
	5072194	1700-0045	Viton gasket for 1/2" & 3/4" Strainer
	5072218	1700-0057	Buna-N Gasket for 1" & 1 1/4" Strainer
	5072219	1700-0058	Viton Gasket for 1" Strainer
	5116131	3800-0025	50/mesh screen for 1/2" & 3/4" Strainer
Screens	5116132	3800-0026	80/mesh screen for 1/2" & 3/4" Strainer
	5116165	3800-0040	20/mesh screen for 1" Strainer
	5116166	3800-0041	50/mesh screen for 1" Strainer
	5116167	3800-0042	80/mesh screen for 1" Strainer
	5116227	3800-0043	20/mesh screen for 1 1/4" Strainer
	5116228	3800-0044	50/mesh screen for 1 1/4" Strainer
	5116229	3800-0045	80/mesh screen for 1 1/4" Strainer
Bowls	5058035	3351-0005	Strainer bowl for 1/2" & 3/4" Strainer
	5058065	3351-0013	Strainer bowl for 1" & 1 1/4" Strainer
Bowls	5046055	3351-0006	Strainer cap for 3/4" Strainer
Caps	5046081	3351-0014	Strainer cap for 1" Strainer

## POLYPROPYLENE STRAINER

3/4" - 1" - 1-1/4" - 1-1/2"

- Economically priced
- Reinforcing ring for durability
- Non-sticking, heavy-duty threads
- Corrosion resistant for use with most chemicals
- 125 P.S.I. Maximum



	FIMCO Code #	MFG Part #	Description
Complete Strainers	5116213	3350-0034A	3/4" Strainer w/50 mesh screen
	5116214	3350-0035A	3/4" Strainer w/80 mesh screen
	5116215	3350-0058A	1" Strainer w/50 mesh screen
	5116216	3350-0059A	1" Strainer w/80 mesh screen
	5116217	3350-0072A	1 1/4" Strainer w/50 mesh screen
	5116218	3350-0073A	1 1/4" Strainer w/80 mesh screen
	5116219	3350-0113A	1 1/2" Strainer w/50 mesh screen
	5116220	3350-0114A	1 1/2" Strainer w/80 mesh screen
Gaskets	5072299	1700-0091	EPDM Gasket for 3/4" Strainer
	5072298	1700-0092	EPDM Gasket for 1", 1 1/4", 1 1/2" Strainer
Screens	5116246	3800-0029	3/4" screen - 20 mesh
	5116131	3800-0025	3/4" screen - 50 mesh
	5116132	3800-0026	3/4" screen - 80 mesh
	5116165	3800-0040	1" screen - 20 mesh
	5116166	3800-0041	1" screen - 50 mesh
	5116167	3800-0042	1" screen - 80 mesh
	5116227	3800-0043	1 1/4" screen - 20 mesh
	5116228	3800-0044	1 1/4" screen - 50 mesh
	5116229	3800-0045	1 1/4" screen - 80 mesh
	5116230	3800-0065	1 1/2" screen - 20 mesh
	5116231	3800-0066	1 1/2" screen - 50 mesh
5116232	3800-0067	1 1/2" screen - 80 mesh	

**HYPRO®**

# TEEJET SPRAYER CONTROLS

## 744A SPRAYER CONTROL KITS

- Manual spray controller in a compact package
- Choice of liquid filled 100 PSI (7 bar) or 300 PSI (20 bar) gauge.
- Lighted pressure gauge for night use
- Heavy-duty switches with LED indicators
- Available in a variety of kit forms using solenoid or ball type control valves
- DirectoValve shutoff ball valves are ordered separately



144A-1 Solenoid Shutoff Valve

### HOW TO ORDER

744A - 100 - L - 3  
 Controller Model Gauge Scale Gauge Type Boom Sections  
 744A 100 PSI/7bar L (Liquid) 1,3 or 5  
 300 PSI/21 bar

MFG Part #	FIMCO Code #	Control Kit #	Description
90-50161	5273404	AAK744A-100L-30S	744A-100L-3 Sprayer Control Unit (Liquid Valve) 244C-3/4 Pressure Reg. Valve
90-50163	5275144	AAK744A-100L-33S	744A-100L-3 Sprayer Control Unit (Liquid Valve) 244C-3/4 Pressure Reg. Valve 144A DirectoValve Boom Section Valves
90-50149	5273446	744A-100L-3	744A-100L-3 Sprayer Control Unit

## DIRECTO VALVE ELECTRONICALLY OPERATED VALVE

One Unit

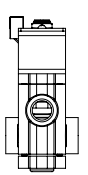

AA144A-1

Two Units

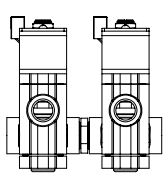

AA144A-2

Three Units

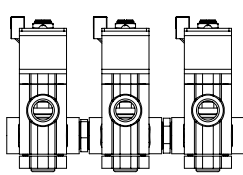

AA144A-3



AA144A

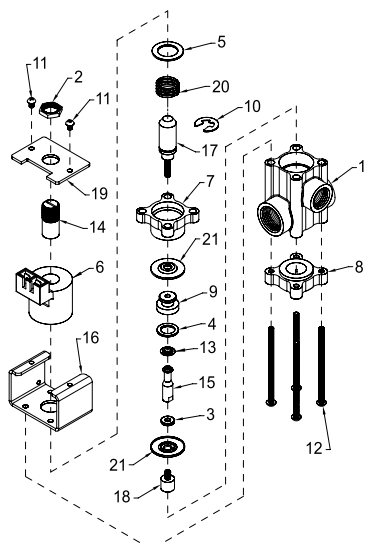

Designed for remote "on-off" control of spray booms and nozzles from operator's location. Operates on a 12 Volt DC system (2 Amp Current Draw). For pressures to 100 P.S.I.

FIMCO Code #	MFG Part #	Description
5143319	AA144A-1	1 Unit Valve
5143320	AA144A-2	2 Unit Valve
5143321	AA144A-3	3 Unit Valve

  

Ref #	FIMCO Code #	MFG Part #	Description
1	5002348	CP14801-PP	Body
2	5006279	CP15168-IENP	Jam Nut
3	5016143	CP14806-SS	Washer
*4	5016144	CP14802-EPR	Seat Washer
5	5016268	CP15169-SS	Washer
6	5054007	CP15163-NYB	Coil Assm, Nylon Encapsulated
7	5084087	CP15164-NYB	Upper Diaphragm Housing
8	5084088	CP15165-NYB	Lower Diaphragm Housing
9	5108037	CP14807-SS	Seat Washer Retainer
10	5108100	CP14813-1-IENP	Retaining Ring
11	5117134	CP14933-SS	#8-32 x 1/4" Round Head
12	5117135	CP14819-SS	#10-24 x 3 3/8" Round Head
13	5127048	CP14811-SS	Spacer
14	5131059	CP15161-IENP	Armature Stop
15	5132037	CP14812-SS	Stem
17	5154046	CP15170-IENP	Armature
18	5154047	CP15162-SS	Lower Diaphragm Piston
19		CP15166-I	Coil Cover, Steel-Nitrotec Finish
*20		CP15167-302SS	Spring
*21		CP36101-EPR	Diaphragm
*	5168755	PK-AB144A-1-KIT	
*	5168756	PK-AB144A-1-VI-KIT	

\*= Available in Spare Parts Kit

# VALVES

## DIRECTO VALVE CONTROL VALVE - MANUALLY OPERATED

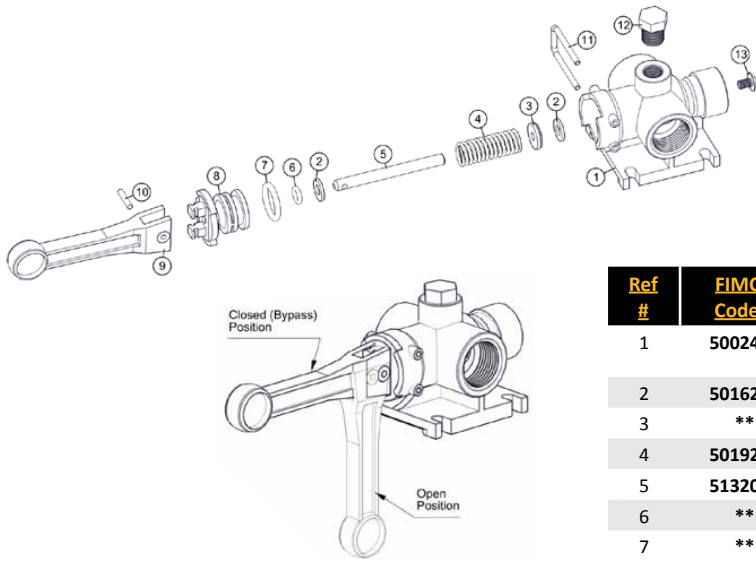

- Corrosion Resistant Materials: Wetted Parts Polypropylene, 316SS and Polyethylene.
- Maximum Pressure - 150 P.S.I.
- Large Capacity - 12.5 G.P.M. @ 5 P.S.I. Pressure Drop.
- 3/4" NPT(F) Inlet Connection.
- 1/2" NPT(F) Spray Line Connection.
- 3/4" NPT(F) Continuous By-Pass Connection.
- Valves May Be Connected w/close Nipples for Multiple Section Spray Control.



Ref #	FIMCO Code #	Qty	MFG Part #	Description
1	5002476	1	CP36303-PP	Poly Body (Black) for Valve Model No. AA6B
2	5016280	2	CP36307-PPB	Washer
3	**	1	CP38726-VI	Shut-Off Washer, Viton
4	5019230	1	CP36306-302SS	Spring
5	5132071	1	CP36304-SS	Stem
6	**	1	CP7717-2/108-VI	O-Ring, Viton
7	**	1	CP7717-2/209-VI	O-Ring, Viton
8	5086043	1	CP36302-PP	Poly Body Insert, (Black)
9	5078178	1	CP-36301-NY	Handle, Nylon (Gray)
10	5101220	1	CP36308-SS	Groove Pin
11	5053091	1	CP36309-302SS	Retaining Clip
12	--	1	--	Pipe Plug, 1/4" MNPT
13	5117281	1	CP38725-SS	#10-24 x 5/16" Phillips Truss Head Machine Screw

FIMCO Code #	MFG Part #	Description
5143316	AA6B	Control Valve
5168718	PK-AB6B-KIT	Repair Kit (Marked **)

\*\* Available Only in Repair Kit

◆◆ Only Available in Complete Assembly

## PRESSURE REGULATORS

The 1560A Electric Pressure Regulator is equipped with a precision high torque motor and gear reduction, and high strength valve body for heavy-duty service. Chemical resistant glass-filled nylon body, stainless steel motor shaft and butterfly, and viton seal. Low current draw, 50 MA at 12 volts. Maximum recommended pressure is 150 PSI. Speed at 12 volts is 1 RPM; at 6 volts is 1/2 RPM.

**5143193**  
TIR 3/4" Pressure Regulator

**5143224**  
TIR 1" Pressure Regulator



## 244 - 3/4 REMOTE CONTROL ELECTRIC REGULATING VALVE

MFG Part #	FIMCO Code #	Description
35-50049	5273448	Remote Control Electric - Regulating Valve



The 244C-3/4 butterfly valve provides remote pressure control. Features two-wire lead for use in 12VDC system, reduced pressure loss (5 psi for 45 G.P.M. flow), and maximum operating pressure of 100 P.S.I. 3/4" NPT (F) connections. Two gallon per minute by-pass at 10 p.s.i. and four gallon per minute by-pass at 40 p.s.i. when the valve is fully closed. Low current draw (0.15 amp).



### NO. 17 SELECTOR TEE VALVE

Choice of 7 Indexed Spray Boom Settings

Side Connection for by-pass and pressure relief valve

FIMCO Code #	MFG Part #	Description
5143295	AA17-L	3/4" FNPT Boom & 3/4" Valve & Gun Outlets
5143298	AA17-Y	3/4" FNPT Boom & 1" & 3/4" Valve & Gun Outlets

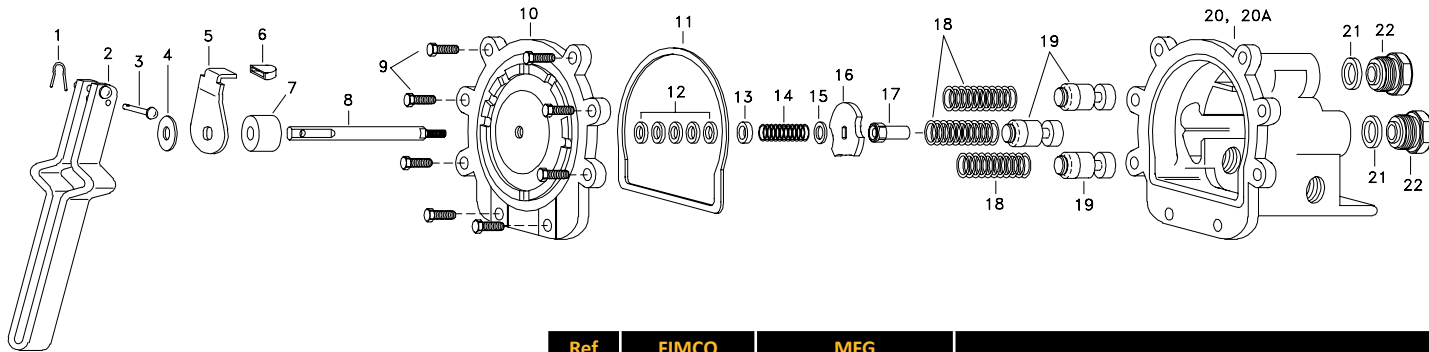

Ref #	FIMCO Code #	MFG Part #	Description
*1	Available In Kit Only		1/16" x 1/2" SS Cotter Pin
2	5078065	CP6849-1-IZP	Handle
*3	Available In Kit Only		Rivet
*4	Available In Kit Only		Handle Washer
5	5120011	CP12128-IZP	Selector Shield
*6	Available In Kit Only		Selector Shield Tip, Celcon
7	5127032	CP12129-CE	Spacer, Celcon
8	5132010	CP6972-SS	Main Stem, stainless steel
*9	Available In Kit Only		Hex Head Screw, 1/4-20 x 3/4"
10	5017090	CP12126-AL	CoverPlate, Alum.
*11	Available In Kit Only		Gasket, Buna N
*12	Available In Kit Only		Packing, Thermo Leather, (5 Reqd)
13	5097032	CP12130-SS	Packing Gland, Stainless Steel
14	5019059	CP7254-SS	Main Spring, Stainless Steel
15	5016062	CP7987-SS	Washer, Stainles Steel
16	5045008	CP6971-AL	Selector Cam, Alum
17	5006068	CP6973-SS	Guide Nut
18	5019057	CP6959-SS	Spring, Stainless steel (3 Reqd)
19	5132021	CP6956-CE	Valve Stem, Celcon (3 Reqd.)
20	5002253	CP6934-3/4-AL	Body, Aluminum
*21	Available In Kit Only		Seat Plate, Poly (3 Reqd.)
22	5005095	CP7902-AL	Outlet Adapter (3 Reqd.)
23	5005259	CP50116-AL	Inlet Adapter 1" M x 3/4"F (for17L)
5168135	PK-AB17-KIT		Repair Parts Kit Items Marked*

Connection	Model #
Inlet Conn, 3/4" NPT	17L
Inlet Conn. 1" NPT	17Y
Boom Outlets (3)	3/4" NPT
GunJet Outlet	
Accessory Outlets	3/4" NPT

Side Connection for spray gun

TeeValve remains shut off during selection of setting,

Lever is raised to open valve in indexed setting is lowered to close valve without changing index position. Gives fast positive "on-off" operation at ends of crop rows.

# VALVES

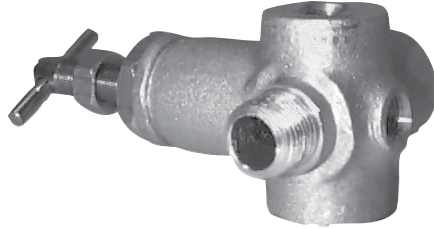

	FIMCO Code #	MFG Part #	Description	PORT SIZE	
				Inlet	Outlet
<b>POLY MANIFOLD</b>	5143358	TMO75/050	Poly Manifold	(1)3/4"	(8)1/2" - 1/4"
<b>ALUMINUM MANIFOLD BY-PASS VALVE</b>	5143066	2142-2	Aluminum Manifold-By-Pass 0-600 PSI	(1)1/2"	(3)3/8" - (1)1/4"
<b>HAMILTON NYLON REGULATOR VALVE</b>	5143336	2064-05-58	Nylon Pressure Relief Valve	(1)1/2"	(1) 3/4"
	5143337	2066-05-58	Nylon Pressure Relief Valve	(1)3/4"	(1) 3/4"



FIMCO Code #	NPT Size	Description
5271298	8460-1/2 w/ 1/2" NPT Connections	Nylon Valve
5271299	8460-3/4 w/ 3/4" NPT Connections	Nylon Valve

Bypasses excess liquid. Choice of 1/2" and 3/4" NPT sizes. Chemical resistant diaphragm seals off operating parts from contact with chemicals remains resilient for chatter-free, responsive pressure control.

Nylon inlet body with aluminum bonnet. Choice of 1/2" or 3/4" NPT (M) inlet and (F) outlet connections. Flow rates to 56 GPM for 1/2" size and to 70 GPM for 3/4" size.

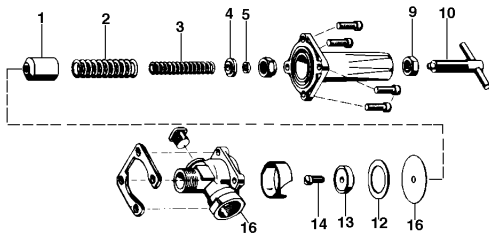

Ref #	FIMCO Code #	MFG Part #	Description
1	5124023	CP8367-AL	Guide Sleeve
*2	Available In Kit Only		Outside Spring
*3	Available In Kit Only		Inside Spring
4	5108026	CP8371-AL	Spring Retainer
*5	Available In Kit Only		Washer, Nylon
9	5006073	CP5898-AL	Lock Nut
10	5271372	CP5896-AL SS	Adjusting Stem
*11	Available In Kit Only		Diaphragm
12	5110079	CP8365-304SS	Stop Ring
*13	Available In Kit Only		Seat, Nylon
14	5117091	CP8477-IZP	Screw
16	5002244	CP8361-1/2 NYB	Body, Nylon 1/2"
16	5002245	CP8361-3/4 NYB	Body, Nylon 3/4"
*	5168186	PK-AB8460-KIT	Repair Parts Kit-Marked w/*



# PRESSURE RELIEF VALVES

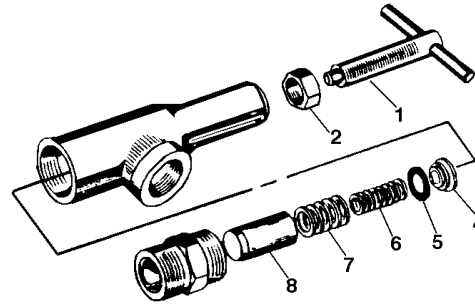

Model 6815

## PISTON TYPE PRESSURE RELIEF/REGULATING VALVES

Ref #	FIMCO Code #	MFG Part #	Description
	5143031	6815-1/2-300	Brass Valve (0-300 PSI)
	5143034	6815-3/4-300	Brass Valve (0-300 PSI)
1	5271372	CP5896-ALSS	Stem, Aluminum & SS
2	5006085	CP5898	Lock Nut, Brass
2	5006073	CP5898-AL	Lock Nut, Aluminum
x4	CP6545	Available In Kit Only	Spring Retainer, Brass
x*5	CP5899-BU	Available In Kit Only	Gasket
x*6	CP6547-SS	Available In Kit Only	Inside Spring
x*7	CP6546-SS	Available In Kit Only	Outside Spring
*8	CP6544-AL	Available In Kit Only	Guide Seat, Aluminum
	5168379	PK-AB6815-300-KIT	Brass Repair Kit Marked x

- Brass with stainless steel springs. • Choice of 1/2" or 3/4" NPT (M) inlet & (F) outlet connections.
- For pressures to 300 P.S.I.

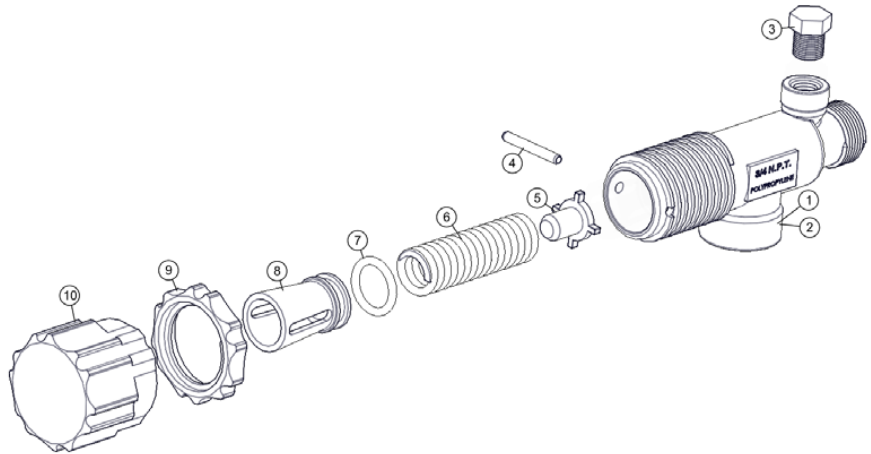

Model 23120

## PISTON TYPE PRESSURE RELIEF/REGULATING VALVES

Bypasses excess liquid. Adjustable to maintain control of line pressure at any pressure within the valve operating range. Selected pressure setting firmly held in place by locknut. Extra large valve passages to handle large flows.

Ref #	FIMCO Code #	MFG Part #	Description
	5143200	23120-1/2-PP	1/2" Poly Valve
	5143199	23120-3/4-PP	3/4" Poly Valve
*4	Available In Kit Only		Retainer Pin
5	5115078	CP23125-PP	Guide Seat
*6	Available In Kit Only		Spring
*7	Available In Kit Only		O Ring Gasket
9	5110266	CP23123-PP	Lock Ring
10	5046270	CP23122-NY	Adjusting Cap
*	5168717	PK-AB23120-KIT	Repair Kit Items Marked *

How to Order: Specify valve no. Example: 23120-1/2-PP Polypropylene

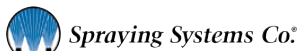

- Polypropylene with stainless steel spring
- Excellent chemical resistance
- EPDM O Rings
- For pressures to 150 psi
- 1/4" port for pressure gauge
- Choice of 1/2" or 3/4" NPT (M) inlet & (F) outlet connections

# SPRAY NOZZLE PARTS

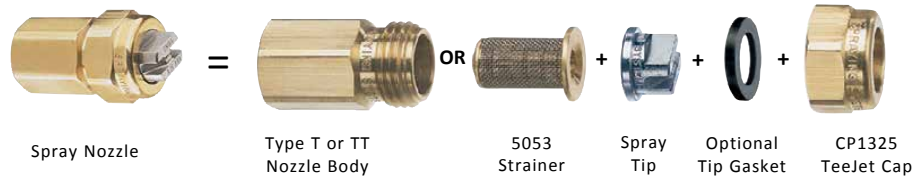

## NOZZLE BODIES



FIMCO Code #	MFG Part #	Description
5002298	CP1336	1/8 TT Male Brass Body
5002294	CP1322	1/4 TT Male Brass Body
5002296	CP8028-NYB	1/4 TT Male Nylon Body



FIMCO Code #	MFG Part #	Description
5002306	CP1335	1/8 T Female Brass Body
5002302	CP1321	1/4 T Female Brass Body
5002304	CP12094-NYB	1/4 T Female Nylon Body



FIMCO Code #	MFG Part #	Description
5046022	CP1325	Brass Nozzle Cap
5046118	CP20230	Brass, For Use With Ceramic Discs and Cores
5046052	8027	White Nylon Nozzle Cap
5046126	38027	Black Poly Nozzle Cap



FIMCO Code #	MFG Part #	Description
5046100	CP18032A-NYB	Winged Teejet Nylon Cap



FIMCO Code #	MFG Part #	Description
5005074	4676-1/4	1/4" Brass Adapter (Same thread as nozzle cap)
5005137	4676-NYB-1/4	1/4" Nylon Adapter (Same thread as nozzle cap)



FIMCO Code #	MFG Part #	Description
5116046	5053-50-SS	Brass Screen Assy w/50 Mesh SS Screen
5116047	5053-100-SS	Brass Screen Assy w/100 Mesh SS Screen
5116033	CP2930-50-SS	50 Mesh Stainless Steel Screen Only for 5053
5116032	CP2930-100-SS	100 Mesh Stainless Steel Screen Only for 5053
5116019	8079-PP-50	Polypropylene Screen Assy w/50 Mesh SS Screen
5116020	8079-PP-100	Polypropylene Screen Assy w/100 Mesh SS Screen



FIMCO Code #	MFG Part #	Description
5116112	4514-10	Brass Slotted Strainer 50/Mesh
5116118	4514-NY-10	Nylon Slotted Strainer 50/Mesh



FIMCO Code #	MFG Part #	Description
5116038	4067-SS-50	Stainless Steel Cup Strainer 50/Mesh
5116039	4067-SS-100	Stainless Steel Cup Strainer 100/Mesh



FIMCO Code #	MFG Part #	Description
5116040	4193A-5-50SS	Brass Check Valve & Strainer Assy w/50 Mesh Screen
5116041	4193A-5-100SS	Brass Check Valve & Strainer Assy w/100 Mesh Screen
5116160	4193A-PP-5-50SS	Poly Check Valve & Strainer Assy w/50 Mesh Screen
5116164	4193A-PP-5-100SS	Poly Check Valve & Strainer Assy w/100 Mesh Screen



FIMCO Code #	MFG Part #	Description
5143085	11750 -10	Brass Check Valve for Large Capacity Nozzles
5143187	11750-PP-5	Polypropylene Check Valve for large capacity nozzles

# SPLIT-EYELET & SWIVEL SPRAY NOZZLES



FIMCO Code #	MFG Part #	Description
5056042	7421-3/4 T-NYB	Male Split Eyelet Connector, nylon body-fits 3/4" pipe
5056043	7421-1/2 T-NYB	Male Split Eyelet Connector, nylon body-fits 1/2" pipe



FIMCO Code #	MFG Part #	Description
5056044	7421-3/4 TD	Split Eyelet Nozzle-for Angle Iron Boom-fits 3/4" pipe



FIMCO Code #	MFG Part #	Description
5005073	4676-1/8 Brass	Brass Adapter, same thread as Nozzle Cap - Replaces Nozzle Cap to provide 1/8" outlet
5005074	4676-1/4 Brass	Brass Adapter, same thread as Nozzle Cap - Replaces Nozzle Cap to provide 1/4" outlet
5005137	4676- NYB-1/4	Nylon Adapter, same thread as Nozzle Cap - Replaces Nozzle Cap to provide 1/4" outlet



FIMCO Code #	MFG Part #	Description
5002382	5000-1/4T	Body assy for Swivel, less tip, cap & strainer, brass



FIMCO Code #	MFG Part #	Description
5002383	5540-1/4TT	Body assy for Swivel, less tip, cap & strainer, brass



FIMCO Code #	MFG Part #	Description
5002385	6240-1/4TT	Body assy for Swivel, less tip, cap & strainer, brass





FIMCO Code #	MFG Part #	Description
5002386	7450-2T	Body assy for Swivel, less tip, cap & strainer, brass



FIMCO Code #	MFG Part #	Description
5143201	20900-1/4MXT	1/4M Brass Valve & Nozzle Body
5143202	20900-1/4FXT	1/4F Brass Valve & Nozzle Body
A compact quarter turn "On-Off " ball valve used with interchangeable spray tips. Brass construction. Maximum operating pressure - 400 P.S.I.		

# DROP PIPES & SWIVELS

Drop Pipes are Nylon or Aluminum Pipe with 1/4" Male Pipe Thread on lower end. Attachment fitting type and sizes are listed below.

	FIMCO Code #	MFG Part #	Description
 11/16" - 16 F Nozzle Cap Connection	5056034	12-D	16" Female Aluminum Drop Pipe
	5056035	21-D	20" Female Aluminum Drop Pipe
 11/16" - 16 F Nozzle Cap Connection	5065053	21354-15-NYB	15" Female Nylon Drop Pipe
 Quick TeeJet Nozzle Cap Connection	5056134	21353-6-15-NYB	15" QuickTeeJet Nylon Hose Drop
	5056135	21353-6-24-NYB	24" QuickTeeJet Nylon Hose Drop
 Clamp Fits 7/8", 1", & 1-5/16" Round Tubing. 1-1/4" & 1-1/2" Sq. Tubing, & 2" Diamond Bar. 1/2" Hose Connection.	5056133		16" Heavy Duty Spring Loaded Drop Pipe
	5002180	8600-2-1/4T-NYB	Nylon Double Swivel, Less Cap & Tip
	5002442	QJ8600-2-1/4-NYB	QuickJet Double Swivel
	5002326	7620-T	1/4" Brass Single Swivel Less Cap & Tip
	5002349	8600-1/4T-NYB	1/4" Nylon Single Swivel Less Cap & Tip
	5002441	QJ8600-1/4-NYB	QuickJet Single Swivel
	5002439	QJ1/4T-NYB	Adaptor 1/4" FIPT Adapts to Quick Jet Caps
	5046186	114447A01-CELR	QuickJet Shutoff Cap
	5005074	4676-1/4	1/4" Brass Adapter (Has same thread as-
	5005073	4676-1/8	1/8" Brass Adapter Nozzle Cap)
 TWIN ORIFICE TIPS FLAT SPRAY PATTERN	5138108	TQ150-0*	Double-Outlet Tip, Brass
	5018168	TQ150-0*-SS	Double-Outlet Tip, Stainless Steel

# TANK ACCESSORIES

## HYPRO JET AGITATOR

Jet action increases pump output as much as 3 and 4 times. Delivers volume needed for effective agitation of spray tanks to keep spray materials from settling out. Low pressure unrestricted discharge reduces foaming. Complete with three sizes of interchangeable nozzles that permit control of discharge. Tough, special formula nylon construction. Inlet is 1/2 inch NPT (female) outlet is 3/4 inch NPT (male).

FIMCO Code #	MFG Part #	Description
5014005	3371	3/4" NPT (M) Out 1/2" NPT (F) in
5014014	3371-0019	3/4" NPT (M)
<b>High Volume Jet Agitator</b>		
	3371-0028	3/4" NPT (M)

\*INCLUDES BODY, SPACER RING, & 3 NOZZLES (1 EACH OF 3 SIZES)



## JET AGITATOR

Agitator Mounts in bottom of 3/4" Tank Fitting. Additional 3/4" Thread protrudes to attach Female Pipe Coupling or Hose Barb to Agitator. For larger tanks, extra agitator may also be mounted in End Tank Fitting, to obtain Dual Agitation.

FIMCO Code #	Description
5014011	3/4" Polypropylene Agitator
5010220	3/4" FNPT x 1/2 HB Poly Elbow
5010114	3/4" FNPT x 1/2 HB Nylon Elbow
5010221	3/4" FNPT x 3/4 HB Poly Elbow
5010136	3/4" FNPT x 3/4 HB Nylon Elbow

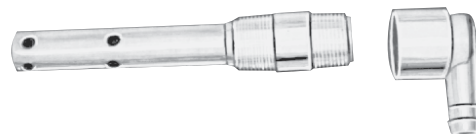

## EDUCTOR NOZZLE (AGITATOR)

- Allows small pumps to circulate large volumes of liquid.
- Manufactured of glass filled polypropylene for excellent corrosion and chemical resistance.
- Large flow opening minimizes plugging

FIMCO Code #	MFG Part #	Description
5014015	Y33180-PP	3/8" Agitator—9 GPM Inlet Flow
5014016	Y9270-PP	3/4" Agitator—13.5 GPM Inlet Flow



FIMCO Code #	MFG Part #	Description
5133207	F12512	2" Poly Tank Strap (Per Foot)
5133220	F12841	3" Poly Tank Strap (150 Ft. Roll - Sold In Full Rolls Only)
5108041	FI 8041	Buckle (Bent) for 1-3/4" Tank Strap
5108042-CNC	FI 8042	Buckle (Straight) for 1-3/4" Tank Strap
5108112-CNC	FI 8112	Buckle (Bent) for 3" Tank Strap
5108111-CNC	FI 8111	Buckle (Straight) for 3" Tank Strap
5034734	FI 4298	Hook Bolt 3/8 x 6"
5034111	FI 4111	Hook Bolt for Buckle 1/2" x 6"



# "QUICKJET" NOZZLE ASSEMBLY SYSTEM

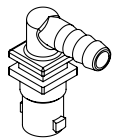

FIMCO Code #	MFG Part #	Description
5056065	18638-111-540-NYB	Single 1/2" Hose Shank Quick Teejet Nozzle Body
5056066	18719-111-785-NYB	Single 3/4" Hose Shank Quick Teejet Nozzle Body
5056113	18635-111-406-NYB	Single 3/8" Hose Shank Quick Teejet Nozzle Body



FIMCO Code #	MFG Part #	Description
5056067	18639-112-540-NYB	Double 1/2" Hose Shank Quick Teejet Nozzle Body
5056068	18720-112-785-NYB	Double 3/4" Hose Shank Quick Teejet Nozzle Body
5056114	18636-112-406-NYB	Double 3/8" Hose Shank Quick Teejet Nozzle Body

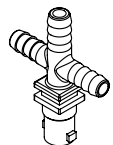

FIMCO Code #	MFG Part #	Description
5056069	18640-113-540-NYB	Triple 1/2" Hose Shank Quick Teejet Nozzle Body
5056070	18721-113-785-NYB	Triple 3/4" Hose Shank Quick Teejet Nozzle Body
5056115	18637-113-406-NYB	Triple 3/8" Hose Shank Quick Teejet Nozzle Body

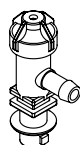

FIMCO Code #	MFG Part #	Description
5056086	22251-311-500-NYB	Single 1/2" Hose Shank w/Diaphragm Check Valve
5056087	22251-311-750-NYB	Single 3/4" Hose Shank w/Diaphragm Check Valve
5056117	22251-311-375-NYB	Single 3/8" Hose Shank w/Diaphragm Check Valve



FIMCO Code #	MFG Part #	Description
5056089	22252-312-500-NYB	Double 1/2" Hose Shank w/Diaphragm Check Valve
5056090	22252-312-750-NYB	Double 3/4" Hose Shank w/Diaphragm Check Valve
5056118	22252-312-375-NYB	Double 3/8" Hose Shank w/Diaphragm Check Valve

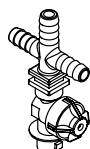

FIMCO Code #	MFG Part #	Description
5056075	19351-213-540-NYB	Triple 1/2" Hose Shank w/Diaphragm Check Valve
5056076	19351-213-785-NYB	Triple 3/4" Hose Shank w/Diaphragm Check Valve
5002413	19351-213-406-NYB	Triple 3/8" Hose Shank w/Diaphragm Check Valve



FIMCO Code #	MFG Part #	Description
5272162	QJ111-3/4	Quick Teejet Clamp Sub Assy for 3/4" Pipe
5272163	QJ111-1	Quick Teejet Clamp Sub Assy for 1" Pipe



FIMCO Code #	MFG Part #	Description
5272164	QJ111SQ-1	Quick Teejet Clamp Sub Assy for 1" Sq Tube
5272165	QJ111SQ-1-1/4	Quick Teejet Clamp Sub Assy for 1 1/4" Sq Tube



FIMCO Code #	MFG Part #	Description
5002375	QJT-NYB	Quick Teejet Adapter w/ Gasket Fits Teejet Nozzle Bodies



FIMCO Code #	MFG Part #	Description
5072308	CP20266-EPDM	Gasket For QJT-NYB & QJT8360-NYB Adapter



FIMCO Code #	MFG Part #	Description
5002376	QJT8360-NYB	Same as QJT-NYB w/Diaphragm Check Valve



FIMCO Code #	MFG Part #	Description
5002380	QJ8360-NYB	Diaphragm Ck. Valve Quick Teejet Nozzle Body Assy.

# QUICK TEEJET & ADAPTER CAPS



## NEW GENERATION OF QUICK TEEJET® CAPS

- Caps constructed of acetal (Celcon) for good strength and chemical resistance.
- Standard gasket constructed of EPDM. Viton is optional.
- Maximum operating pressure of 300 psi (20 bar).
- To order gasket separately use part number CP19438-VI or CP19438-EPR.

CAP COLOR	OLD PART NUMBER (GASKET AND CAP)	NEW PART NUMBER* (GASKET AND CAP)	OLD PART NUMBER (CAP ONLY)	NEW PART NUMBER (CAP ONLY)	OLD CAP	NEW CAP
BLACK	25612-1-NYR	114441A-1-CELR	CP25611-1-NY	CP114440A-1-CE		
WHITE	25612-2-NYR	114441A-2-CELR	CP25611-2-NY	CP114440A-2-CE		
RED	25612-3-NYR	114441A-3-CELR	CP25611-3-NY	CP114440A-3-CE		
BLUE	25612-4-NYR	114441A-4-CELR	CP25611-4-NY	CP114440A-4-CE		
GREEN	25612-5-NYR	114441A-5-CELR	CP25611-5-NY	CP114440A-5-CE		
YELLOW	25612-6-NYR	114441A-6-CELR	CP25611-6-NY	CP114440A-6-CE		
BROWN	25612-7-NYR	114441A-7-CELR	CP25611-7-NY	CP114440A-7-CE		
ORANGE	25612-8-NYR	114441A-8-CELR	CP25611-8-NY	CP114440A-8-CE		
GREY	25612-9-PP	114441A-9-CELR	CP25611-9-PP	CP114440A-9-CE		
VIOLET	25612-10-NYR	114441A-10-CELR	CP25611-10-NY	CP114440A-10-CE		
BLACK	25598-1-NYR	114443A-1-CELR	CP25597-1-NY	CP114442A-1-CE		
WHITE	25598-2-NYR	114443A-2-CELR	CP25597-2-NY	CP114442A-2-CE		
RED	25598-3-NYR	114443A-3-CELR	CP25597-3-NY	CP114442A-3-CE		
BLUE	25598-4-NYR	114443A-4-CELR	CP25597-4-NY	CP114442A-4-CE		
GREEN	25598-5-NYR	114443A-5-CELR	CP25597-5-NY	CP114442A-5-CE		
YELLOW	25598-6-NYR	114443A-6-CELR	CP25597-6-NY	CP114442A-6-CE		
BROWN	25598-7-NYR	114443A-7-CELR	CP25597-7-NY	CP114442A-7-CE		
ORANGE	25598-8-NYR	114443A-8-CELR	CP25597-8-NY	CP114442A-8-CE		
GREY	N/A	114443A-9-CELR	N/A	CP114442A-9-CE		
VIOLET	25598-10-NYR	114443A-10-CELR	CP25597-10-NY	CP114442A-10-CE		
BLACK	25608-1-NYR	114445A-1-CELR	CP25607-1-NY	CP114444A-1-CE		
WHITE	25608-2-NYR	114445A-2-CELR	CP25607-2-NY	CP114444A-2-CE		
RED	25608-3-NYR	114445A-3-CELR	CP25607-3-NY	CP114444A-3-CE		
BLUE	25608-4-NYR	114445A-4-CELR	CP25607-4-NY	CP114444A-4-CE		
GREEN	25608-5-NYR	114445A-5-CELR	CP25607-5-NY	CP114444A-5-CE		
YELLOW	25608-6-NYR	114445A-6-CELR	CP25607-6-NY	CP114444A-6-CE		
BROWN	25608-7-NYR	114445A-7-CELR	CP25607-7-NY	CP114444A-7-CE		
ORANGE	25608-8-NYR	114445A-8-CELR	CP25607-8-NY	CP114444A-8-CE		
GREY	25608-9-PP	114445A-9-CELR	CP25607-9-PP	CP114444A-9-CE		
VIOLET	N/A	114445A-10-CELR	N/A	CP114444A-10-CE		
BLACK	19843-NYR	114447A-1-CELR	N/A	N/A		

\* Cap gasket combo can be ordered with Viton gasket by using CELVI as the material code.















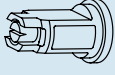









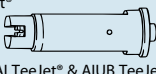





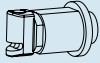





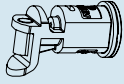





# QUICK TEEJET CAPS

## Quick TeeJet® Caps

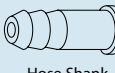
### Color Code

1	2	3	4	5	6	7	8	9	10	11	12	13
Black	White	Red	Blue	Green	Yellow	Brown	Orange	Gray	Violet <sup>3</sup>	Lt. Blue <sup>4</sup>	Raspberry Red <sup>5</sup>	Lt. Green <sup>5</sup>

### Ordering Information

QUICK TEEJET CAPS	PART NUMBER		FOR USE WITH FLAT SPRAY TIPS 300 psi (20 bar) MAXIMUM PRESSURE
	QUICK TEEJET CAP ONLY	QUICK TEEJET CAP & SEAT GASKET SET	
	CP114440A-*-CE	114441A-*-CELR	<b>TeeJet® Flat Spray Tips (Smaller Capacities)</b>  TP Standard -0067 to -08  XR TeeJet -01 to -08  Turbo TwinJet*  AIXR TeeJet* -015 to -06
		114441A-*-CELVI	
	CP25611-9-PP <sup>1</sup>	25612-9-PP <sup>1</sup>	 DG TeeJet*  Turbo TeeJet* -01 to -08  OC TeeJet* & TQ150  APTJ TwinJet
	CP25609-*-NY	25610-*-NYR	<b>TeeJet Flat Spray Tips (Larger Capacities)</b>  TP Standard -10 to -20  XR TeeJet -10 to -15
	CP114442A-*-CE	114443A-*-CELR	 TJ60 TwinJet*  AI TeeJet* & AIUB TeeJet*  AI Turbo TwinJet* -02 to -06  Turbo TeeJet* Induction -01 to -06  DG TwinJet*  Sj3 StreamJet  AIXR TeeJet* -08 to -10
		114443A-*-CELVI	
	CP115834A-*-CE	1158535A-*-CELR	 Turbo TeeJet* Induction -01 to -06
		115835A-*-CELVI	
	CP114501A-*-CE <sup>6</sup>	114502A-*-CELR <sup>6</sup>	 AI Turbo TwinJet* -08 to -15  Turbo TeeJet* Induction -08 to -10  Turbo TeeJet* -10 to -12
		114502A-*-CELVI <sup>6</sup>	
	CP98578-1-NY <sup>2</sup>	98579-1-NYR <sup>2</sup>	 AI3070
	CP25595-*-NY	25596-*-NYR	<b>TeeJet Flat Spray Tips (Smaller Capacities)</b> Tips can be positioned in choice of two spray plane directions—parallel or perpendicular to wings of Quick TeeJet cap.
	CP25599-*-NY	25600-*-NYR	 Turbo FloodJet*  TK-VP FloodJet*  TK-VS FloodJet* Locating Nib
	CP114444A-*-CE	114445A-*-CELR	 TK FloodJet*  FL FullJet*  TX/TXA ConeJet*  TG Full Cone  Hose Shank  AITXA ConeJet
		114445A-*-CELVI	
	CP25607-9-PP <sup>1</sup>	25608-9-PP <sup>1</sup>	
	CP25607-*-NY	—	 Disc  Core Seal CP18999-EPR Disc-Core (Insert Core into Seal)

\*Specify color code (see chart above). <sup>1</sup> These caps only available in gray and rated to 150 psi (10 bar). <sup>2</sup> These caps only available in black.

<sup>3</sup> Color available in CP114440A, CP114442A and CP114444A caps. <sup>4</sup> Color available in CP114440A, CP114442A and CP114501A caps.

<sup>5</sup> Color available in CP114501A and CP114440A caps. <sup>6</sup> This cap offered in Black, White, Light Green, Light Blue and Raspberry Red only.













# QUICK TEEJET CAPS

## Quick TeeJet® Caps

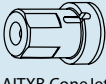
### Color Code

1	2	3	4	5	6	7	8	9	10	11	12	13
Black	White	Red	Blue	Green	Yellow	Brown	Orange	Gray	Violet <sup>3</sup>	Lt. Blue <sup>4</sup>	Raspberry Red <sup>5</sup>	Lt. Green <sup>5</sup>

### Ordering Information



















QUICK TEEJET CAPS	PART NUMBER		FOR USE WITH FLAT SPRAY TIPS 300 psi (20 bar) MAXIMUM PRESSURE
	QUICK TEEJET CAP ONLY	QUICK TEEJET CAP & SEAT GASKET SET	
	CP26277-1-NY <sup>2</sup>	26278-1-NYR <sup>2</sup>	Ceramic Disc-Core     D-Disc    Core    TXB ConeJet    AITXB ConeJet
	CP114395-1-NYB <sup>2</sup>	114396-1-NYR <sup>2</sup>	 114396-1-NYR includes gasket and O-Ring (CP7717-M10.5x1.5-VI) TXR ConeJet
	—	QJ4676-45-1/4-NYR <sup>2</sup>	45° Quick TeeJet cap with 1/4" NPT female threaded outlet
	—	QJ4676-90-1/4-NYR <sup>2</sup>	90° Quick TeeJet cap with 1/4" NPT female threaded outlet
	—	QJ4676-1/8-NYR <sup>2</sup>	Permits use of standard 1/8" and 1/4" nozzles. Can be used for mounting pressure gauge at the nozzle. (B) = BSPT
	—	QJ(B)4676-1/4-NYR <sup>2</sup>	
	—	114447-1-CELR <sup>2</sup>	Provides shutoff at nozzle for quick spacing change or change in spray swath.
	—	114447-1-CELVI <sup>2</sup>	

<sup>2</sup>These caps only available in black.















FIMCO Code #	MFG Part #	Description
5016157	CP19438-EPR	EPDM Seat & Gasket for cap (Standard)
5016158	CP19438-VI	VITON Seat & Gasket for cap (Optional)

### TEEJET TIPS

Nozzles For Soybean Rust & Other Fungicide Applications	DENSITY OF CROP CANOPY			Droplet Sizes	Sizes Available
	Light	Medium	Heavy		
 <b>TwinJet</b>	EXCELLENT	EXCELLENT	EXCELLENT	   	TJ60-11002VS THRU TJ60-11010VS
 <b>XR TeeJet</b>  <b>XRC TeeJet</b>	EXCELLENT	VERY GOOD	GOOD	    	XR8001VS THRU 8008VS XR11001VS THRU XR1108  XRC80015-VS THRU 06 XRC110025-VS THRU 06
 <b>Turbo TeeJet</b>	EXCELLENT	VERY GOOD	GOOD	    	TT11001-VP THRU TT11008-VP







 VERY FINE   
  FINE   
  MEDIUM   
  COARSE   
  VERY COARSE   
  EXTREMELY COARSE

# TEEJET SPRAY TIPS

	Type	Size Type	Orifice Insert Tip Material	Example Tip #
	<b>XR TEEJET®</b> EXTENDED RANGE (TAPERED FLAT SPRAY TIPS)		Stainless Steel/Celcon	XR8001VS
		-01 and Larger	Polymer (110° only)	XR11002-VP
			Ceramic (110° only)	XR11003-VK
	<b>DG TEEJET®</b> DRIFT GUARD (TAPERED FLAT SPRAY TIPS)	80° And 110°	With Polymer Pre-Orifice	DG11002-VP
		-01 Through -05	Stainless Steel/Celcon	DG8002VS
	<b>TEEJET®</b> SPRAY TIPS (TAPERED FLAT SPRAY TIPS)	-0050 Or Smaller	Brass	TP800050
		Larger Than -0050	Brass	TP800067
		Smaller Than -01	Stainless Steel	TP800067-SS
			Stainless Steel	TP8001-SS
	-01 And Larger	Stainless Steel/Celcon	TP8001VS	
	.01 And Larger	Polymer	TP8002VP	
	<b>TEEJET® AIXR</b> SPRAY TIPS (TAPERED FLAT SPRAY TIPS)	-01 And Larger	Polymer	AIXR110015VP
	<b>TEEJET®</b> SPRAY TIPS (TAPERED FLAT SPRAY TIPS)		Brass	TP8001E
		-01 And Larger	Stainless Steel	TP8001E-SS
			Hard. Stainless Steel	TP8001E-HSS
	-01 And Larger	Stainless Steel/Celcon	TP8001EVS	
	<b>TURBO TEEJET®</b> SPRAY TIPS (WIDE ANGLE FLAT SPRAY)	-01 Thru -05	Polymer (110° Only)	TT11001-VP
	<b>FLOODJET®</b> SPRAY TIPS (WIDE ANGLE FLAT SPRAY)		Brass	TK-3
		All Sizes	Stainless Steel	TK-SS3
		All Sizes	Stainless Steel/Celcon	TK-VS3
	<b>TURBO FLOODJET®</b> SPRAY TIPS (WIDE ANGLE FLAT SPRAY)	All Sizes	Stainless Steel/Celcon	TF-VS4
			Polymer	TF-VP4
	<b>AI TEEJET®</b> SPRAY TIPS (TAPERED FLAT SPRAY)	-015 THRU -10	Stainless Steel/Celcon	AI110015-VS
	<b>TX CONEJET®</b> SPRAY TIPS (HOLLOW CONE SPRAY)		Brass	TX-1
			Stainless Steel	TX-SS1
		All Sizes	Stainless Steel	TX-VS4
			Ceramic	TX-VK4
	<b>TEEJET®</b> ORIFICE PLATES	All Sizes	Stainless Steel	CP4916-49
	<b>TEEJET®</b> PLUG TIPS		Brass	CP3942
			Aluminum	CP3942-AL
			Stainless Steel	CP3942-SS

# TEEJET SPRAY TIPS (FIMCO ITEM NUMBER CONVERSION)

	FIMCO PART #	MFG PART #
AI TIP 	PK-AI110015-VS PK-AI110025-VS PK-AI11002-VS PK-AI11003-VS PK-AI11004-VS PK-AI11005-VS PK-AI11006-VS PK-AI11008-VS	PK-AI110015-VS PK-AI110025-VS PK-AI11002-VS PK-AI11003-VwS PK-AI11004-VS PK-AI11005-VS PK-AI11006-VS PK-AI11008-VS
AI TIP/CAP 	PK-AIC110015-VS PK-AIC110025-VS PK-AIC11002-VS PK-AIC11003-VS PK-AIC11004-VP PK-AIC11004-VS PK-AIC11005-VS PK-AIC11006-VS PK-AIC11008-VS PK-AIC11010-VS	PK-AIC110015-VS PK-AIC110025-VS PK-AIC11002-VS PK-AIC11003-VS PK-AIC11004-VP PK-AIC11004-VS PK-AIC11005-VS PK-AIC11006-VS PK-AIC11008-VS PK-AIC11010-VS
AI/TURBO TWINJET 	PK-AITTJ60-110025VP PK-AITTJ60-11002VP PK-AITTJ60-11003VP PK-AITTJ60-11004VP PK-AITTJ60-11005VP PK-AITTJ60-11006VP	PK-AITTJ60-110025VP PK-AITTJ60-11002VP PK-AITTJ60-11003VP PK-AITTJ60-11004VP PK-AITTJ60-11005VP PK-AITTJ60-11006VP
AIXR TIPS 	PK-AIXR110015VP PK-AIXR110025-VP PK-AIXR11002-VP PK-AIXR11003-VP PK-AIXR11004-VP PK-AIXR11005-VP PK-AIXR11006VP	PK-AIXR110015VP PK-AIXR110025VP PK-AIXR11002VP PK-AIXR11003VP PK-AIXR11004VP PK-AIXR11005VP PK-AIXR11006VP
DG TIP 	PK-DG8002-VS PK-DG8003-VS PK-DG8004-VS	PK-DG8002-VS PK-DG8003-VS PK-DG8004-VS
BRASS TIP 4 PK 	7772040 7772041 7772042 7772043 7772044	PK-OC-02 PK-OC-03 PK-OC-04 PK-OC-06 PK-OC-08
STREAMJET 	7772047 7772048 7772049 7772050	PK-SJ3-06-VP PK-SJ3-08-VP PK-SJ3-10-VP PK-SJ3-15-VP
TURBO FLOODJET 	7771588 7771586 7771946 7771341 7771584 7771585 7771587 7771333 7771334 7771335 7771336 7771337 7771338	PK-TF-VP10 PK-TF-VP2 PK-TF-VP2.5 PK-TF-VP3 PK-TF-VP4 PK-TF-VP5 PK-TF-VP7.5 PK-TF-VS2 PK-TF-VS2.5 PK-TF-VS3 PK-TF-VS4 PK-TF-VS5 PK-TF-VS7.5
FULL CONE TIP 	7771590 7771591	PK-TG-3 PK-TG-5
FLOODJET TIP 	7771248 7771028 7771029 7771030 7771031 7771032 7771249 7771075 7771076 7771077 7772079 7772051 PK-TK-VP1.5-ZA PK-TK-VP1-ZA PK-TK-VP2.5-ZA PK-TK-VP2-ZA 7771251 7771252 7771253 7771254 7771255 7771256 7771257 7772052	PK-TK-1.5 PK-TK-2 PK-TK-2.5 PK-TK-3 PK-TK-4 PK-TK-5 PK-TK-7.5 PK-TK-SS3 PK-TK-SS4 PK-TK-SS5 PK-TKT-VP3 PK-TKT-VP5 PK-TK-VP1.5-ZA PK-TK-VP1-ZA PK-TK-VP2.5-ZA PK-TK-VP2-ZA PK-TK-VS10 PK-TK-VS2 PK-TK-VS2.5 PK-TK-VS3 PK-TK-VS4 PK-TK-VS5 PK-TK-VS7.5 PK-TP110015
SPAY TIP 	PK-TP110015VS PK-TP11002-VS 7771002 7771267 7771004 7771005 7771006 7771007 7771269 7771271 7771013 7771272	PK-TP110015VS PK-TP11002-VS PK-TP730077 PK-TP730116 PK-TP730154 PK-TP730231 PK-TP730308 PK-TP730385 PK-TP730462 PK-TP730616 PK-TP8001 PK-TP80015

	FIMCO PART #	MFG PART #
SPRAY TIPS 	7771274 7771276 7771918 7771277 7771037 7771279 7771015 7771039 7771280 7771919 7771281 7771016 7771040 7771282 7771920 7771283 7771017 7771041 7771284 7771921 7771285 7771018 7771042 7771286 7771922 7771287 7771288 7771043 7771923 7771291 7771292 7772053 7771293 7771294	PK-TP80015E PK-TP80015EVS PK-TP80015VP PK-TP80015VS PK-TP8001E PK-TP8001VS PK-TP8002 PK-TP8002E PK-TP8002EVS PK-TP8002VP PK-TP8002VS PK-TP8003 PK-TP8003E PK-TP8003EVS PK-TP8003VP PK-TP8003VS PK-TP8004 PK-TP8004E PK-TP8004EVS PK-TP8004VP PK-TP8004VS PK-TP8005 PK-TP8005E PK-TP8005EVS PK-TP8005VP PK-TP8005VS PK-TP8006 PK-TP8006E PK-TP8006VP PK-TP8006VS PK-TP8008 PK-TP8008VP PK-TP8008VS PK-TP8010
TURBO TEEJET 	7771571 7771570 PK-TT110025-VP 7771572 7771573 7771574 7771575 PK-TT11006-VP PK-TT11008-VP PK-TT110015-VP PK-TT110025-VP PK-TT11002-VP PK-TT11003-VP PK-TT11004-VP PK-TT11005-VP PK-TT11006-VP PK-TT11008-VP PK-TT11010-VP	PK-TT110015-VP PK-TT11001-VP PK-TT110025-VP PK-TT11002-VP PK-TT11003-VP PK-TT11004-VP PK-TT11005-VP PK-TT11006-VP PK-TT11008-VP PK-TT110015-VP PK-TT110025-VP PK-TT11002-VP PK-TT11003-VP PK-TT11004-VP PK-TT11005-VP PK-TT11006-VP PK-TT11008-VP PK-TT11010-VP
TURBO TWINJET 	PK-TTJ60-110025-VP PK-TTJ60-11002-VP PK-TTJ60-11003-VP PK-TTJ60-11004-VP PK-TTJ60-11005VP PK-TTJ60-11006VP	PK-TTJ60-110025VP PK-TTJ60-11002VP PK-TTJ60-11003VP PK-TTJ60-11004VP PK-TTJ60-11005VP PK-TTJ60-11006VP
CONEJET TIP 	7771295 7771296 7771297 7771298 7771300 7771301 7771302 7771303 7771304	PK-TX-1 PK-TX-10 PK-TX-12 PK-TX-18 PK-TX-26 PK-TX-3 PK-TX-4 PK-TX-6 PK-TX-8
XR TIPS 	7771924 7771312 7771925 7771313 7771926 7771314 7771927 7771315 PK-XR11005-VP 7771316 7771317 PK-XR11008-VS 7771140 7771139 7771141 7771142 7771143 7771144 7771145 7771318 PK-XRC10025-VS PK-XRC11003-VS PK-XRC11004-VS PK-XRC11005-VS	PK-XR110015VS PK-XR11001VS PK-XR11002-VP PK-XR11002-VS PK-XR11003-VP PK-XR11003-VS PK-XR11004-VP PK-XR11004-VS PK-XR11005-VP PK-XR11005-VS PK-XR11006-VS PK-XR11008-VS PK-XR8001VS PK-XR8001VS PK-XR8002VS PK-XR8003VS PK-XR8004VS PK-XR8005VS PK-XR8006VS PK-XR8008VS PK-XRC110025-VS PK-XRC11003-VS PK-XRC11004-VS PK-XRC11005-VS
TIP 4 PK 	7772040 7772041 7772042 7772043 7772044	PK-OC-02 PK-OC-03 PK-OC-04 PK-OC-06 PK-OC-08

# TEEJET PARTS (FIMCO ITEM NUMBER CONVERSION)

FIMCO PART #	MFG PART #	DESCRIPTION
<b>NOZZLE BODIES</b>		
7771928	PK-18635-111-406-NYB-2	SINGLE HOSE SHANK,NY
7771148	PK-18636-112-406-NYB-2	DBLE HOSE SHANK, NYB
PK-18637-113-406-NYB-2	PK-18637-113-406-NYB-2	QUICK TEEJET 3/8"
7771929	PK-18638-111-540-NYB-2	SINGLE HOSE SHANK
7771930	PK-18639-112-540-NYB-2	DOUBLE HOSE SHANK
PK-18640-113-540-NYB-2	PK-18640-113-540-NYB-2	QUICK TEEJET 1/2"
7771947	PK-18719-111-785-NYB-2	SINGLE HOSE SHANK,NY
7771948	PK-18720-112-785-NYB-2	DOUBLE HOSE SHANK,NY
7771933	PK-19349-211-406-NYB-2	HOSE SHANK ASB
7771931	PK-19349-211-540-NYB-2	HOSE SHANK ASB
7772071	PK-19350-212-406-NYB-2	HOSE SHANK ASB
7771932	PK-19350-212-540-NYB-2	HOSE SHANK ASB
7772072	PK-19351-213-406-NYB-2	HOSE SHANK ASB
7772073	PK-19351-213-540-NYB-2	HOSE SHANK ASB
7771809	PK-22251-311-500-NYB-2	HOSE SHANK ASB
7771810	PK-22251-311-750-NYB-2	HOSE SHANK ASB
7771811	PK-22252-312-500-NYB-2	HOSE SHANK ASB
7771812	PK-22252-312-750-NYB-2	HOSE SHANK ASB
7771527	PK-8120-NYB-406TD	HOSE SHANK ADAPTER
7771516	PK-8120-NYB-540TD	HOSE SHK.ADP.
7771526	PK-8121-NYB-406TD	HOSE SHANK ADAPTER
7771517	PK-8121-NYB-540TD	HOSE SHANK ADAPTER
PK8400-406NY	PK-8400-406-NYB	HOSE CONNECTION 3/8"
PK-8400-500-NYB	PK-8400-500-NYB	HOSE CONNECTION 1/2"
7771182	PK-8600-1/4T-NYB	SWV.BDY ASB
7771529	PK-8600-2-1/4T-NYB	SWV.BDY ASB.
PK-8600-2-1/4T-NYB-2	PK-8600-2-1/4T-NYB-2	SWIVEL BODY ASB
PK-QJ1/4T-NYB	PK-QJ1/4T-NYB	QJ-1/4T QUICKJT,BODY
7771227	PK-QJ1/4TT-NYB	QJ BODY
7772075	PK-QJ17560A-1-NYB-2	SPLIT EYELET CV (2 PK)
7772076	PK-QJ17560A-3/4-NYB-2	SPLIT EYELET CV (2 PK)
7772096	PK-QJ4676-1/4-NYR	ADAPTER
7771234	PK-QJ8360-NYB	CHEM SAVER
PK-QJ8600-1/4-NYB-2	PK-QJ8600-1/4-NYB-2	QJ SWIVEL BODY ASB (2 PK)
PK-QJ8600-1/4T-NYB-2	PK-QJ8600-1/4T-NYB-2	SWIVEL BODY ASB
PK-QJ8600-2-1/4-NYB-2	PK-QJ8600-2-1/4-NYB-2	QJ SWIVEL BODY ASB (2 PK)
7771238	PK-QJT8360-NYB	NOZ.BDY ADP.
7771237	PK-QJT-NYB	NOZ.BDY ADP.



FIMCO PART #	MFG PART #	DESCRIPTION
<b>STRAINERS</b>		
PK-41938-5-100SS	PK-41938-5-100SS	TEEJET CHECK VALVE
7771508	PK-41938-5-50SS	TEEJET CHECK VALVE
7771536	PK-41938-PP-5-100SS	TEEJET CHECK VALVE
7772074	PK-41938-PP-5-24SS	TEEJET CHECK VALVE
7771535	PK-41938-PP-5-50SS	TEEJET CHECK VALVE
PK-4514-32	PK-4514-32	SLOTTED STR.
7771171	PK-4514-NY-10	SLOTTED STR.
7771172	PK-4514-NY-20	SLOTTED STR.
7771173	PK-4514-NY-32	SLOTTED STR.
7771505	PK-5053-100-SS	TEEJET STRAINER
PK-5053-100-SS-10	PK-5053-100-SS-10	TEEJET STRAINER
7771504	PK-5053-50-SS	TEEJET STRAINER
7771507	PK-8079-PP-100	TEEJET STRAINER
PK-8079-PP-100-10	PK-8079-PP-100-10	TEEJET STRAINER QTY 10
PK-8079-PP-100-ZA	PK-8079-PP-100-ZA	TEEJET STRAINER QTY 10
7772015	PK-8079-PP-24	TEEJET STRAINER
7771506	PK-8079-PP-50	TEEJET STRAINER
PK-8079-PP-50-10	PK-8079-PP-50-10	TEEJET STRAINER QTY 10
PK-8079-PP-50-ZA	PK-8079-PP-50-ZA	TEEJET STRAINER QTY 10



FIMCO PART #	MFG PART #	DESCRIPTION
<b>BOOM CLAMPS</b>		
7771502	PK-AA111-1	VARI SPACE CLAMP
PK-AA111-1/2	PK-AA111-1/2	VARI-SPACE CLAMP
7771501	PK-AA111-3/4	VARI-SPC.CLP.
7771503	PK-AA111SQ-1	VARI-SPC.CLP.
PK-AA111SQ-1-1/2	PK-AA111SQ-1-1/2	VARI-SPACE CLAMP
7771185	PK-AA111SQ-1-1/4	VARI-SPC CLP
7771228	PK-QJ111-1	VARI-SPC.CLP
7771230	PK-QJ111-3/4	VARI-SPC.CLP
7771231	PK-QJ111SQ-1	VARI-SPC CLP
7771817	PK-QJ111SQ-1-1/2	VARI-SPC CLP
7771232	PK-QJ111SQ-1-1/4	VARI-SPC CLP
7772045	PK-QJ111SQ-3/4	3/4" SQUARE CLAMP (2 PK)
7772082	PK-D7	ORIFICE DISC, HSS
7772078	PK-D8	ORIFICE DISC, HSS
PK-DC13-NY	PK-DC13-NY	TEEJET CORE, NYLON
PK-DC23-NY	PK-DC23-NY	TEEJET CORE, NYLON
7772097	PK-DC25	TEEJET CORE, BRASS
PK-DC25-NY	PK-DC25-NY	TEEJET CORE, NYLON
7771215	PK-DC35	TEEJET CORE.BRASS (12 PK)
7772039	PK-DC45	TEEJET CORE.BRASS (12 PK)
PK-DC45-NY	PK-DC45-NY	TEEJET CORE, NYLON
PK-DC46-NY	PK-DC46-NY	TEEJET CORE, NYLON
PK-DC56-NY	PK-DC56-NY	TEEJET CORE, NYLON

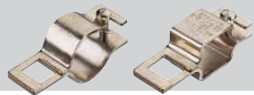

FIMCO PART #	MFG PART #	DESCRIPTION
<b>ADJUSTABLE TIP</b>		
7771915	PK-38720-PPB-X18	ADJ.CONEJET TIP,BR.
7771174	PK-4676-1/4	OUTLET ADAPT.
7771178	PK-4676-NYB-1/4	OUTLET ADAPT.
PK-5500-PPB-X18	PK-5500-PPB-X18	ADJ.CONEJET TIP,BR.
7771914	PK-5500-X8	ADJ. CONEJET TIP, BR



FIMCO PART #	MFG PART #	DESCRIPTION
<b>FITTINGS</b>		
7771191	PK-CP12094-NYB	TEEJET BODY
7771192	PK-CP1321	TEEJET BODY
7771193	PK-CP1322	TEEJET BODY
7771523	PK-CP1325	TEEJET CAP
7772016	PK-CP18032A-NYB	NYLON TEEJET CAP (4 PK)
7771194	PK-CP18999-EPR	SEAL EPDM RUBBER (12 PK)
7771195	PK-CP19438-EPR	SEAT GASKET
PK-CP19438-EPR-10	PK-CP19438-EPR-10	SEAT GASKET, QTY 10
7771945	PK-CP19438-VI	SEAT GASKET
7771196	PK-CP21953-EPR	CHEM.SAV.DIA.
PK-CP21953-EPR-12	PK-CP21953-EPR-12	CHEM/SAV DIAPHRAM
7771199	PK-CP3942	PLUG TIP
7772038	PK-CP3942-SS	BLK PLUG TIP,SS,1/4T (4 PK)
7771524	PK-CP8027-NYB	TEEJET CAP
7771202	PK-CP8028-NYB	TEEJET BODY



FIMCO PART #	MFG PART #	DESCRIPTION
<b>DISC</b>		
7771203	PK-D1	ORIFICE DISC,HARD.SS (12 PK)
PK-D10	PK-D10	ORIFICE DISC, HSS
7772080	PK-D2	ORIFICE DISC, HSS
7771206	PK-D3	ORIFICE DISC, HSS
7772081	PK-D4	ORIFICE DISC, HSS
7771208	PK-D5	ORIFICE DISC, HSS
7771209	PK-D6	ORIFICE DISC, HSS
7772082	PK-D7	ORIFICE DISC, HSS
7772078	PK-D8	ORIFICE DISC, HSS
PK-DC13-NY	PK-DC13-NY	TEEJET CORE, NYLON
PK-DC23-NY	PK-DC23-NY	TEEJET CORE, NYLON
7772097	PK-DC25	TEEJET CORE, BRASS
PK-DC25-NY	PK-DC25-NY	TEEJET CORE, NYLON
7771215	PK-DC35	TEEJET CORE.BRASS (12 PK)
7772039	PK-DC45	TEEJET CORE.BRASS (12 PK)
PK-DC45-NY	PK-DC45-NY	TEEJET CORE, NYLON
PK-DC46-NY	PK-DC46-NY	TEEJET CORE, NYLON
PK-DC56-NY	PK-DC56-NY	TEEJET CORE, NYLON



# TEEJET SPRAY TIPS

## XR TeeJet® Extended Range Flat Spray Tips

Tip Size

### Typical Applications:

General use tip that provides excellent coverage particularly when applying insecticides, fungicides or contact herbicides.

### Features:

- Excellent spray distribution over a wide range of pressures — 15–60 PSI (1–4 bar).
- Ideal for rigs equipped with sprayer controllers.
- Reduces drift at lower pressures, better coverage at higher pressures.
- Available in stainless steel, ceramic and polymer in 80° and 110° spray angles with VisiFlo® color-coding.

- Ceramic is available with corrosive-resistant polypropylene VisiFlo color-coded tip holder in 80° capacities 03–08 and 110° capacities 02–08.
- XR110025 only available in VK.
- XR80025 and XR80035 only available in VS.
- Brass available in 110° only.
- Automatic spray alignment with 114441-\*—CELQ Quick TeeJet® cap and gasket.
- Automatic spray alignment for sizes 10 and 15 with 25610-\*—NYR Quick TeeJet cap and gasket.

XR8001VS thru XR8008VS

XR11001VS thru XR11008VS

For use with the 114441A TeeJet cap

XR80015-VS thru XR8006-VS

XR80010SS thru XR8015SS

XR11010SS thru XR11015SS

For use with the 25610 TeeJet cap

Tip Size	PSI	DROP SIZE		CAPACITY ONE NOZZLE IN GPM	CAPACITY ONE NOZZLE IN OZ./MIN.	GPA										GALLONS PER 1000 SQ. FT.				
		80°	110°			4 MPH	5 MPH	6 MPH	8 MPH	10 MPH	12 MPH	15 MPH	20 MPH	2 MPH	3 MPH	4 MPH	5 MPH			
						20°														
XR8001	15	F	F	0.061	7.8	4.5	3.6	3.0	2.3	1.8	1.5	1.2	0.91	0.21	0.14	0.10	0.08			
	20	F	F	0.071	9.1	5.3	4.2	3.5	2.6	2.1	1.8	1.4	1.1	0.24	0.16	0.12	0.10			
	30	F	F	0.087	11	6.5	5.2	4.3	3.2	2.6	2.2	1.7	1.3	0.30	0.20	0.15	0.12			
	40	F	F	0.10	13	7.4	5.9	5.0	3.7	3.0	2.5	2.0	1.5	0.34	0.23	0.17	0.14			
	50	F	F	0.11	14	8.2	6.5	5.4	4.1	3.3	2.7	2.2	1.6	0.37	0.25	0.19	0.15			
60	F	VF	0.12	15	8.9	7.1	5.9	4.5	3.6	3.0	2.4	1.8	0.41	0.27	0.20	0.16				
XR80015	15	M	F	0.092	12	6.8	5.5	4.6	3.4	2.7	2.3	1.8	1.4	0.31	0.21	0.16	0.13			
	20	M	F	0.11	14	8.2	6.5	5.4	4.1	3.3	2.7	2.2	1.6	0.37	0.25	0.19	0.15			
	30	M	F	0.13	17	9.7	7.7	6.4	4.8	3.9	3.2	2.6	1.9	0.44	0.29	0.22	0.18			
	40	M	F	0.15	19	11.1	8.9	7.4	5.6	4.5	3.7	3.0	2.2	0.51	0.34	0.26	0.20			
	50	M	F	0.17	22	12.6	10.1	8.4	6.3	5.0	4.2	3.4	2.5	0.58	0.39	0.29	0.23			
60	M	F	0.18	23	13.4	10.7	8.9	6.7	5.3	4.5	3.6	2.7	0.61	0.41	0.31	0.24				
XR8002	15	M	M	0.12	15	8.9	7.1	5.9	4.5	3.6	3.0	2.4	1.8	0.41	0.27	0.20	0.16			
	20	M	M	0.14	18	10.4	8.3	6.9	5.2	4.2	3.5	2.8	2.1	0.48	0.32	0.24	0.19			
	30	M	F	0.17	22	12.6	10.1	8.4	6.3	5.0	4.2	3.4	2.5	0.58	0.39	0.29	0.23			
	40	M	F	0.20	26	14.9	11.9	9.9	7.4	5.9	5.0	4.0	3.0	0.68	0.45	0.34	0.27			
	50	M	F	0.22	28	16.3	13.1	10.9	8.2	6.5	5.4	4.4	3.3	0.75	0.50	0.37	0.30			
60	M	F	0.24	31	17.8	14.3	11.9	8.9	7.1	5.9	4.8	3.6	0.82	0.54	0.41	0.33				
XR80025	15	M	M	0.15	19	11.1	8.9	7.4	5.6	4.5	3.7	3.0	2.2	0.51	0.34	0.26	0.20			
	20	M	M	0.18	23	13.4	10.7	8.9	6.7	5.3	4.5	3.6	2.7	0.61	0.41	0.31	0.24			
	30	M	F	0.22	28	16.3	13.1	10.9	8.2	6.5	5.4	4.4	3.3	0.75	0.50	0.37	0.30			
	40	M	F	0.25	32	18.6	14.9	12.4	9.3	7.4	6.2	5.0	3.7	0.85	0.57	0.43	0.34			
	50	M	F	0.28	36	21	16.6	13.9	10.4	8.3	6.9	5.5	4.2	0.95	0.63	0.48	0.38			
60	M	F	0.31	40	23	18.4	15.3	11.5	9.2	7.7	6.1	4.6	1.1	0.70	0.53	0.42				
XR8003	15	M	M	0.18	23	13.4	10.7	8.9	6.7	5.3	4.5	3.6	2.7	0.61	0.41	0.31	0.24			
	20	M	M	0.21	27	15.6	12.5	10.4	7.8	6.2	5.2	4.2	3.1	0.71	0.48	0.36	0.29			
	30	M	F	0.26	33	19.3	15.4	12.9	9.7	7.7	6.4	5.1	3.9	0.88	0.59	0.44	0.35			
	40	M	F	0.30	38	22	17.8	14.9	11.1	8.9	7.4	5.9	4.5	1.0	0.68	0.51	0.41			
	50	M	F	0.34	44	25	20	16.8	12.6	10.1	8.4	6.7	5.0	1.2	0.77	0.58	0.46			
60	M	F	0.37	47	27	22	18.3	13.7	11.0	9.2	7.3	5.5	1.3	0.84	0.63	0.50				
XR80035	15	M	M	0.21	27	15.6	12.5	10.4	7.8	6.2	5.2	4.2	3.1	0.71	0.48	0.36	0.29			
	20	M	M	0.25	32	18.6	14.9	12.4	9.3	7.4	6.2	5.0	3.7	0.85	0.57	0.43	0.34			
	30	M	F	0.30	38	22	17.8	14.9	11.1	8.9	7.4	5.9	4.5	1.0	0.68	0.51	0.41			
	40	M	F	0.35	45	26	21	17.3	13.0	10.4	8.7	6.9	5.2	1.2	0.79	0.60	0.48			
	50	M	F	0.39	50	29	23	19.3	14.5	11.6	9.7	7.7	5.8	1.3	0.88	0.66	0.53			
60	M	F	0.43	55	32	26	21	16.0	12.8	10.6	8.5	6.4	1.5	0.97	0.73	0.58				
XR8004	15	C	M	0.24	31	17.8	14.3	11.9	8.9	7.1	5.9	4.8	3.6	0.82	0.54	0.41	0.33			
	20	M	M	0.28	36	21	16.6	13.9	10.4	8.3	6.9	5.5	4.2	1.0	0.63	0.48	0.38			
	30	M	M	0.35	45	26	21	17.3	13.0	10.4	8.7	6.9	5.2	1.2	0.79	0.60	0.48			
	40	M	M	0.40	51	30	24	19.8	14.9	11.9	9.9	7.9	5.9	1.4	0.91	0.68	0.54			
	50	F	F	0.45	58	33	27	22	16.7	13.4	11.1	8.9	6.7	1.5	1.0	0.77	0.61			
60	F	F	0.49	63	36	29	24	18.2	14.6	12.1	9.7	7.3	1.7	1.1	0.83	0.67				
XR8005	15	C	M	0.31	40	23	18.4	15.3	11.5	9.2	7.7	6.1	4.6	1.1	0.70	0.53	0.42			
	20	M	M	0.35	45	26	21	17.3	13.0	10.4	8.7	6.9	5.2	1.2	0.79	0.60	0.48			
	30	M	M	0.43	55	32	26	21	16.0	12.8	10.6	8.5	6.4	1.5	0.97	0.73	0.58			
	40	M	M	0.50	64	37	30	25	18.6	14.9	12.4	9.9	7.4	1.7	1.1	0.85	0.68			
	50	M	F	0.56	72	42	33	28	21	16.6	13.9	11.1	8.3	1.9	1.3	0.95	0.76			
60	F	F	0.61	78	45	36	30	23	18.1	15.1	12.1	9.1	2.1	1.4	1.0	0.83				
XR8006	15	C	M	0.37	47	27	22	18.3	13.7	11.0	9.2	7.3	5.5	1.3	0.84	0.63	0.50			
	20	M	M	0.42	54	31	25	21	15.6	12.5	10.4	8.3	6.2	1.4	1.0	0.71	0.57			
	30	M	M	0.52	67	39	31	26	19.3	15.4	12.9	10.3	7.7	1.8	1.2	0.88	0.71			
	40	M	M	0.60	77	45	36	30	22	17.8	14.9	11.9	8.9	2.0	1.4	1.0	0.82			
	50	M	M	0.67	86	50	40	33	25	19.9	16.6	13.3	9.9	2.3	1.5	1.1	0.91			
60	M	F	0.73	93	54	43	36	27	22	18.1	14.5	10.8	2.5	1.7	1.2	0.99				
XR8008	15	VC	C	0.49	63	36	29	24	18.2	14.6	12.1	9.7	7.3	1.7	1.1	0.83	0.67			
	20	VC	C	0.57	73	42	34	28	21	16.9	14.1	11.3	8.5	1.9	1.3	0.97	0.78			
	30	VC	C	0.69	88	51	41	34	26	20	17.1	13.7	10.2	2.3	1.6	1.2	0.94			
	40	M	M	0.80	102	59	48	40	30	24	19.8	15.8	11.9	2.7	1.8	1.4	1.1			
	50	M	M	0.89	114	66	53	44	33	26	22	17.6	13.2	3.0	2.0	1.5	1.2			
60	M	M	0.98	125	73	58	49	36	29	24	19.4	14.6	3.3	2.2	1.7	1.3				
XR8010 †	15	XC	VC	0.61	78	45	36	30	23	18.1	15.1	12.1	9.1	2.1	1.4	1.0	0.83			
	20	VC	C	0.71	91	53	42	35	26	21	17.6	14.1	10.5	2.4	1.6	1.2	0.97			
	30	VC	C	0.87	111	65	52	43	32	26	22	17.2	12.9	3.0	2.0	1.5	1.2			
	40	M	M	1.00	128	74	59	50	37	30	25	19.8	14.9	3.4	2.3	1.7	1.4			
	50	M	M	1.12	143	83	67	55	42	33	28	22	16.6	3.8	2.5	1.9	1.5			
60	M	M	1.22	156	91	72	60	45	36	30	24	18.1	4.1	2.8	2.1	1.7				
XR8015 †	15	XC	VC	0.92	118	68	55	46	34	27	23	18.2	13.7	3.1	2.1	1.6	1.3			
	20	XC	VC	1.06	136	79	63	52	39	31	26	21	15.7	3.6	2.4	1.8	1.4			
	30	VC	VC	1.30	166	97	77	64	48	39	32	26	19.3	4.4	2.9	2.2	1.8			
	40	VC	C	1.50	192	111	89	74	56	45	37	30	22	5.1	3.4	2.6	2.0			
	50	VC	C	1.68	215	125	100	83	62	50	42	33	25	5.7	3.8	2.9	2.3			
60	VC	C	1.84	236	137	109	91	68	55	46	36	27	6.3	4.2	3.1	2.5				

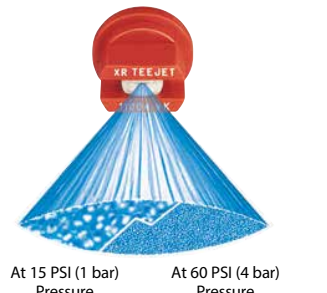

CONTACT PRODUCT	SYSTEMIC PRODUCT	DRIFT MANAGEMENT
EXCELLENT	GOOD	GOOD
GOOD*	VERY GOOD *	VERY GOOD *

\*At pressures below 30 PSI (2.0 bar)

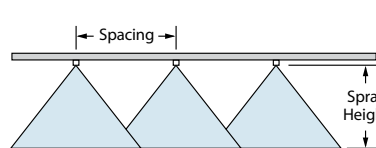

Optimum Spray Height	
80°	30"
110°	20"

Note: Always double check your application rates. Tabulations are based on spraying water at 70°F (21°C). See pages 136–157 for drop size classification, useful formulas and other information. † Available in all stainless steel only.

# TEEJET SPRAY TIPS

## Turbo TeeJet® Wide Angle Flat Spray Tips

Tip Size

TT1100\*-VP

For use with the 114441A TeeJet cap

### Typical Applications:

Mid-range droplet size offers very good coverage with moderate drift control. Ideal for contact products, including herbicides, fungicides and insecticides.

### Features:

- Tapered edge wide angle flat spray pattern for uniform coverage in broadcast spraying.
- Large, rounded internal passage to minimize clogging.
- Excellent resistance to corrosive solutions.
- Superior wear characteristics.
- Larger droplets for less drift — 15–90 PSI (1–6 bar).
- Automatic spray alignment with 114441- \*CELRL Quick TeeJet cap and gasket for capacities 01 thru 08; 114502- \*CELRL for capacities 10 and 12. 98579-1-NYR
- Unique internal configuration means substantially longer wear life.

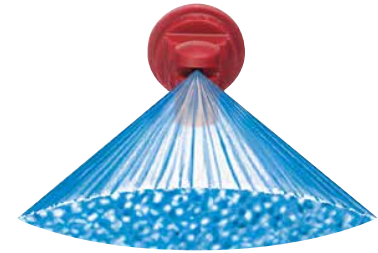

TI	PSI	DROPS PER MIN	CAPACITY ONE NOZZLE IN GPM	CAPACITY ONE NOZZLE IN OZ./MIN	GPA										GALLONS PER 1000 SQ. FT.				
					20"										2 MPH	3 MPH	4 MPH	5 MPH	
					4 MPH	5 MPH	6 MPH	8 MPH	10 MPH	12 MPH	15 MPH	20 MPH							
TT11001 (100)	15	C	0.061	7.8	4.5	3.6	3.0	2.3	1.8	1.5	1.2	0.91	0.21	0.14	0.10	0.08			

CONTACT PRODUCT	SYSTEMIC PRODUCT	DRIFT MANAGEMENT
VERY GOOD	VERY GOOD	VERY GOOD
GOOD*	EXCELLENT*	VERY GOOD*

\*At pressures below 30 PSI (2.0 bar)

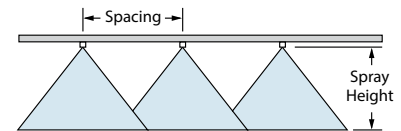

### Optimum Spray Height

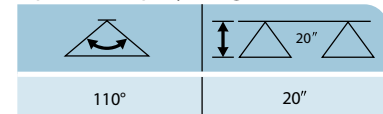

### How to order:

Specify tip number.

Example:

TT11001-VP – Polymer with VisiFlo® color-coding

TT11002-VP-CE – Polymer with VisiFlo color-coding, includes Quick TeeJet cap and gasket

Note: Always double check your application rates. Tabulations are based on spraying water at 70°F (21°C).

# TEEJET SPRAY TIPS

## AIXR TeeJet®

Air Induction XR Flat Spray Tips

Tip Size

AIXR1100\*VP

For use with the 114441A TeeJet cap

### Typical Applications:

Air induction design provides good drift control while still providing coverage. Ideal for a wide range of application including post-emerge systemic products.

### Features:

- 110° wide, tapered flat spray angle with air induction technology offers better drift management.
- Made of a two-piece UHMWPE polymer construction with VisiFlo® color-coding. UHMWPE provides excellent chemical resistance, including acids, as well as exceptional wear life.

- Compact size to prevent tip damage.
- Depending on the chemical, produces large air-filled drops through a Venturi air aspirator.
- Removable pre-orifice.
- Available in nine tip capacities with a wide operating pressure range: 15–90 PSI (1–6 bar).
- Automatic spray alignment with 114441\*-CELQuick TeeJet® cap and gasket for capacities 015 thru 06; 114443\*-CELQuick for capacities 08 thru 10.

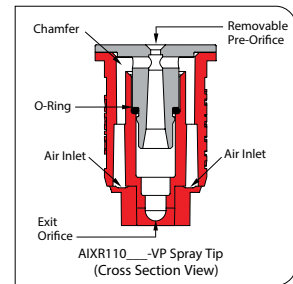

TIPOLOGY	PSI	DROPSIZE	CAPACITY ONE NOZZLE IN GPM	CAPACITY ONE NOZZLE IN OZ./MIN.	20"										GALLONS PER 1000 SQ. FT.						
					GPA																
					4 MPH	5 MPH	6 MPH	8 MPH	10 MPH	12 MPH	15 MPH	20 MPH	2 MPH	3 MPH	4 MPH	5 MPH					
AIXR110015 (100)	15	XC	0.092	12	6.8	5.5	4.6	3.4	2.7	2.3	1.8	1.4	0.31	0.21	0.16	0.13					
	20	VC	0.11	14	8.2	6.5	5.4	4.1	3.3	2.7	2.2	1.6	0.37	0.25	0.19	0.15					
	30	C	0.13	17	9.7	7.7	6.4	4.8	3.9	3.2	2.6	1.9	0.44	0.29	0.22	0.18					
	40	M	0.14	19	11.1	8.9	7.4	5.6	4.5	3.7	3.0	2.2	0.51	0.34	0.25	0.20					
	50	M	0.17	22	12.6	10.1	8.4	6.3	5.0	4.2	3.4	2.5	0.58	0.39	0.29	0.23					
AIXR11002 (50)	60	M	0.18	23	13.4	10.7	8.9	6.7	5.3	4.5	3.6	2.7	0.61	0.41	0.31	0.24					
	75	M	0.21	27	15.6	12.5	10.4	7.8	6.2	5.2	4.2	3.1	0.71	0.48	0.36	0.29					
	90	M	0.23	29	17.1	13.7	11.4	8.5	6.8	5.7	4.6	3.4	0.78	0.52	0.39	0.31					
	15	XC	0.12	15	8.9	7.1	5.9	4.5	3.6	3.0	2.4	1.8	0.41	0.27	0.20	0.16					
	20	VC	0.14	18	10.4	8.3	6.9	5.2	4.2	3.5	2.8	2.1	0.48	0.32	0.24	0.19					
AIXR110025 (50)	30	C	0.17	22	12.6	10.1	8.4	6.3	5.0	4.2	3.4	2.5	0.58	0.39	0.29	0.23					
	40	C	0.20	26	14.9	11.9	9.9	7.4	5.9	5.0	4.0	3.0	0.68	0.45	0.34	0.27					
	50	C	0.22	28	16.3	13.1	10.9	8.2	6.5	5.4	4.4	3.3	0.75	0.50	0.37	0.30					
	60	M	0.24	31	17.8	14.3	11.9	8.9	7.1	5.9	4.8	3.6	0.82	0.54	0.41	0.33					
	75	M	0.27	35	20	16.0	13.4	10.0	8.0	6.7	5.3	4.0	0.92	0.61	0.46	0.37					
AIXR11003 (50)	90	M	0.30	38	22	17.8	14.9	11.1	8.9	7.4	5.9	4.5	1.0	0.68	0.51	0.41					
	15	XC	0.15	19	11.1	8.9	7.4	5.6	4.5	3.7	3.0	2.2	0.51	0.34	0.26	0.20					
	20	XC	0.18	23	13.4	10.7	8.9	6.7	5.3	4.5	3.6	2.7	0.61	0.41	0.31	0.24					
	30	C	0.22	28	16.3	13.1	10.9	8.2	6.5	5.4	4.4	3.3	0.75	0.50	0.37	0.30					
	40	C	0.25	32	18.6	14.9	12.4	9.3	7.4	6.2	5.0	3.7	0.85	0.57	0.43	0.34					
AIXR11004 (50)	50	C	0.28	36	21	16.6	13.9	10.4	8.3	6.9	5.5	4.2	0.95	0.63	0.48	0.38					
	60	C	0.31	39	23	18.4	15.3	11.5	9.1	7.4	5.9	4.5	1.1	0.70	0.53	0.42					
	75	C	0.34	44	25	20	16.8	12.6	10.1	8.4	6.7	5.0	1.2	0.77	0.58	0.46					
	90	M	0.38	49	28	23	18.8	14.1	11.3	9.4	7.5	5.6	1.3	0.86	0.65	0.52					
	15	XC	0.18	23	13.4	10.7	8.9	6.7	5.3	4.5	3.6	2.7	0.61	0.41	0.31	0.24					
AIXR11005 (50)	20	VC	0.21	27	15.6	12.5	10.4	7.8	6.2	5.2	4.2	3.1	0.71	0.48	0.36	0.29					
	30	VC	0.26	33	19.3	15.4	12.9	9.7	7.7	6.4	5.1	3.9	0.88	0.59	0.44	0.35					
	40	VC	0.30	38	22	17.8	14.9	11.1	8.9	7.4	5.9	4.5	1.0	0.68	0.51	0.41					
	50	C	0.34	44	25	20	16.8	12.6	10.1	8.4	6.7	5.0	1.2	0.77	0.58	0.46					
	60	C	0.37	47	27	22	18.3	13.7	11.0	9.2	7.3	5.5	1.3	0.84	0.63	0.50					
AIXR11006 (50)	75	C	0.41	52	30	24	20	15.2	12.2	10.1	8.1	6.1	1.4	0.93	0.70	0.56					
	90	M	0.45	58	33	27	22	16.7	13.4	11.1	8.9	6.7	1.5	1.0	0.77	0.61					
	15	UC	0.24	17	14.3	11.9	8.9	7.1	5.9	4.8	3.6	2.8	0.82	0.54	0.41	0.33					
	20	XC	0.28	36	21	16.6	13.9	10.4	8.3	6.9	5.5	4.2	0.95	0.63	0.48	0.38					
	30	XC	0.35	45	26	21	17.3	13.0	10.4	8.7	6.9	5.2	1.2	0.79	0.60	0.48					
AIXR11008 (50)	40	VC	0.40	51	30	24	19.8	14.9	11.9	9.9	7.9	5.9	1.4	0.91	0.68	0.54					
	50	VC	0.45	58	33	27	22	16.7	13.4	11.1	8.9	6.7	1.5	1.0	0.77	0.61					
	60	VC	0.49	63	36	29	24	18.2	14.6	12.1	9.7	7.3	1.7	1.1	0.83	0.67					
	75	C	0.55	70	41	33	27	20	16.3	13.6	10.9	8.2	1.9	1.2	0.94	0.75					
	90	C	0.60	77	45	36	30	22	17.8	14.9	11.9	8.9	2.0	1.4	1.0	0.82					
AIXR11010	15	UC	0.31	40	23	18.4	15.3	11.5	9.2	7.7	6.1	4.6	1.1	0.70	0.53	0.42					
	20	XC	0.35	45	26	21	17.3	13.0	10.4	8.7	6.9	5.2	1.2	0.79	0.60	0.48					
	30	XC	0.43	55	32	26	21	16.0	12.8	10.6	8.5	6.4	1.5	0.97	0.73	0.58					
	40	VC	0.50	64	37	30	25	18.6	14.9	12.4	9.9	7.4	1.7	1.1	0.85	0.68					
	50	VC	0.56	72	42	33	28	21	16.6	13.9	11.1	8.3	1.9	1.3	0.95	0.76					
AIXR11004VP	60	C	0.61	78	45	36	30	23	18.1	15.1	12.1	9.1	2.1	1.4	1.0	0.83					
	75	C	0.68	87	50	40	34	25	20	16.8	13.5	10.1	2.3	1.5	1.2	0.92					
	90	C	0.75	96	56	45	37	28	22	18.6	14.9	11.1	2.6	1.7	1.3	1.0					
	15	UC	0.37	47	27	22	18.3	13.7	11.0	9.2	7.3	5.5	1.3	0.84	0.63	0.50					
	20	XC	0.42	54	31	25	21	15.6	12.5	10.4	8.3	6.2	1.4	0.95	0.71	0.57					
AIXR11003VP-CE	30	XC	0.52	67	39	31	26	19.3	15.4	12.9	10.3	7.7	1.8	1.2	0.88	0.71					
	40	VC	0.60	77	45	36	30	22	17.8	14.9	11.9	8.9	2.0	1.4	1.0	0.82					
	50	VC	0.67	86	50	40	33	25	19.9	16.6	13.3	9.9	2.3	1.5	1.1	0.91					
	60	VC	0.73	93	54	43	36	27	22	18.1	14.5	10.8	2.5	1.7	1.2	0.99					
	75	C	0.82	105	61	49	41	30	24	20	16.2	12.2	2.8	1.9	1.4	1.1					
AIXR11008VP	90	C	0.90	121	67	53	43	33	27	22	17.8	13.4	3.1	2.0	1.5	1.2					
	15	UC	0.49	63	36	29	24	18.2	14.6	12.1	9.7	7.3	1.7	1.1	0.83	0.67					
	20	UC	0.57	73	42	34	28	21	16.9	14.1	11.3	8.5	1.9	1.3	0.97	0.78					
	30	XC	0.69	88	51	41	34	26	20	17.1	13.7	10.2	2.3	1.6	1.2	0.94					
	40	XC	0.80	102	59	48	40	30	24	19.8	15.8	11.9	2.7	1.8	1.4	1.1					
AIXR11010VP	50	VC	0.89	114	66	53	44	33	26	22	17.6	13.2	3.0	2.0	1.5	1.2					
	60	VC	1.00	128	74	59	49	37	30	25	19.8	14.9	3.4	2.3	1.7	1.4					
	75	VC	1.10	141	82	65	54	41	33	27	22	16.3	3.7	2.5	1.9	1.5					
	90	C	1.20	154	89	71	59	45	36	30	24	17.8	4.1	2.7	2.0	1.6					
	15	UC	0.61	78	45	36	30	23	18.1	15.1	12.1	9.1	2.1	1.4	1.0	0.83					
AIXR11010VP	20	UC	0.71	91	53	42	35	26	21	17.6	14.1	10.5	2.4	1.6	1.2	0.97					
	30	UC	0.87	111	65	52	43	32	26	22	17.2	12.9	3.0	2.0	1.5	1.2					
	40	VC	1.00	128	74	59	49	37	30	25	19.8	14.9	3.4	2.3	1.7	1.4					
	50	VC	1.12	143	83	67	55	42	33	28	22	16.6	3.8	2.5	1.9	1.5					
	60	VC	1.22	156	91	72	60	45	36	30	24	18.1	4.2	2.8	2.1	1.7					

# TEEJET SPRAY TIPS

## Turbo FloodJet® Wide Angle Flat Spray Tips

### Tip Size

TF-VS\*

For use with the 25600 TeeJet cap

TF-VP\*

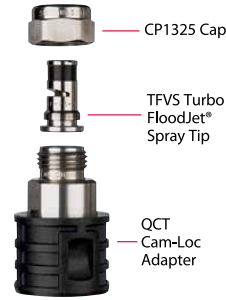

**BROADCAST NOZZLES**

	DROPS	PSI	DROP SIZE	CAPACITY ONE NOZZLE IN GPM	CAPACITY ONE NOZZLE IN OZ./MIN.	40°										20°				
						GPA										GALLONS PER 1000 SQ. FT.				
						4 MPH	5 MPH	6 MPH	8 MPH	10 MPH	12 MPH	15 MPH	20 MPH	2 MPH	3 MPH	4 MPH	5 MPH			
TF-VS2 (50)	10	XC	0.20	26	7.4	5.9	5.0	3.7	3.0	2.5	2.0	1.5	0.68	0.45	0.34	0.27				
	20	XC	0.28	36	10.4	8.3	6.9	5.2	4.2	3.5	2.8	2.1	0.95	0.63	0.48	0.38				
	30	XC	0.35	45	13.0	10.4	8.7	6.5	5.2	4.3	3.5	2.6	1.2	0.79	0.60	0.48				
TF-VS2.5 (50)	10	XC	0.25	32	9.3	7.4	6.2	4.6	3.7	3.1	2.5	1.9	0.85	0.57	0.43	0.34				
	20	XC	0.35	45	13.0	10.4	8.7	6.5	5.2	4.3	3.5	2.6	1.2	0.79	0.60	0.48				
	30	XC	0.43	55	16.0	12.8	10.6	8.0	6.4	5.3	4.3	3.2	1.5	0.97	0.73	0.58				
TF-VS3 (50)	10	XC	0.50	64	18.6	14.9	12.4	9.3	7.4	6.2	5.0	3.7	1.7	1.1	0.85	0.68				
	20	XC	0.30	38	11.1	8.9	7.4	5.6	4.5	3.7	3.0	2.2	1.0	0.68	0.51	0.41				
	30	XC	0.42	54	15.6	12.5	10.4	7.8	6.2	5.2	4.2	3.1	1.4	0.95	0.71	0.57				
TF-VS4 (50)	10	XC	0.52	67	19.3	15.4	12.9	9.7	7.7	6.4	5.1	3.9	1.8	1.2	0.88	0.71				
	20	XC	0.60	77	22	17.8	14.9	11.1	8.9	7.4	5.9	4.5	2.0	1.4	1.0	0.82				
	30	XC	0.40	51	14.9	11.9	9.9	7.4	5.9	5.0	4.0	3.0	1.4	0.91	0.68	0.54				
TF-VS5	10	XC	0.40	51	14.9	11.9	9.9	7.4	5.9	5.0	4.0	3.0	1.4	0.91	0.68	0.54				
	20	XC	0.57	73	21	16.9	14.1	10.6	8.5	7.1	5.6	4.2	1.9	1.3	0.97	0.78				
	30	XC	0.69	88	26	20	17.1	12.8	10.2	8.5	6.8	5.1	2.3	1.6	1.2	0.94				
TF-VS7.5	10	XC	0.80	102	30	24	19.8	14.9	11.9	9.9	7.9	5.9	2.7	1.8	1.4	1.1				
	20	XC	0.50	64	18.6	14.9	12.4	9.3	7.4	6.2	5.0	3.7	1.7	1.1	0.85	0.68				
	30	XC	0.71	91	26	21	17.6	13.2	10.5	8.8	7.0	5.3	2.4	1.6	1.2	0.97				
TF-VS10	10	XC	0.87	111	32	26	22	16.1	12.9	10.8	8.6	6.5	3.0	2.0	1.5	1.2				
	20	XC	1.00	128	37	30	25	18.6	14.9	12.4	9.9	7.4	3.4	2.3	1.7	1.4				
	30	XC	1.28	156	48	39	32	24	19.3	16.1	12.9	9.7	4.4	2.9	2.2	1.8				
TF-VS10	10	XC	1.50	192	56	45	37	28	22	18.6	14.9	11.1	5.1	3.4	2.6	2.0				
	20	XC	1.00	128	37	30	25	18.6	14.9	12.4	9.9	7.4	3.4	2.3	1.7	1.4				
	30	XC	1.41	180	52	42	35	26	21	17.4	14.0	10.5	4.8	3.2	2.4	1.9				
TF-VS10	30	XC	1.73	221	64	51	43	32	26	21	17.1	12.8	5.9	3.9	2.9	2.4				
	40	XC	2.00	256	74	59	50	37	30	25	19.8	14.9	6.8	4.5	3.4	2.7				

Note: Always double check your application rates. Tabulations are based on spraying water at 70°F (21°C). †Specify material.



### Features:

- Excellent spray distribution for uniform coverage along the boom.
- Nozzle design incorporates a pre-orifice to produce larger droplets for less drift.
- Large, round orifice reduces clogging.
- Stainless steel or polymer with VisiFlo® color-coding band for easy size identification.

### Optimum Spray Height

Tip Size	Optimum Spray Height
20"	24**
30"	30**
40"	39**

CONTACT PRODUCT	SYSTEMIC PRODUCT	DRIFT MANAGEMENT
—	VERY GOOD	EXCELLENT

\*Wide angle spray nozzle height is influenced by nozzle orientation. The critical factor is to achieve a minimum 30% overlap.

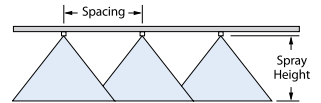

## EVEN FLAT SPRAY TIPS

### TYPICAL APPLICATIONS:

**BEST:** Pre-Emerge Herbicides for band application of surface applied herbicides. Used at medium pressures (20-40 P.S.I.) to produce medium size droplets and to control drift.

**BEST:** Post-Emerge Systemic Herbicides-Used at lower pressures (20-30 P.S.I.) for banding systemic herbicides.

**GOOD:** Post-Emerge Contact Herbicides-For band application of contact herbicides, used at 40 psi & above to produce small droplets for better coverage. Features:

- Ideal for banding over the row or in row middles.
- Provides uniform distribution throughout the flat spray pattern.
- Easily mounted on spray boom or planter.
- Tip materials include brass, stainless steel, and hardened stainless steel.
- Available in a range of capacities in 40°, 80° and 95° spray angles.
- VisiFlo color-coded system available in 80° spray angle.

Band Width	Approximate Spray Height			Conversion Factors**
	40° Series	80° Series	95° Series	
8"	10"	5"	4"	3.8
10"	12"	6"	5"	3.0
12"	14"	7"	6"	2.5
15"	19"	9"	8"	2.0

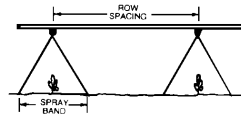

Tip Size	Type
TP8001E	Brass
TP8001E-SS	Stainless
TP8001EV5	Stainless Steel w/ VisiFlo Color Coding

Tip Color VisiFlo Version	TIP NO. (STRAINER SCREEN SIZE)	Liquid Pressure in PSI	Capacity 1 Nozzle in GPM	Capacity 1 Nozzle in oz./min	GPA - GALLONS PER ACRE*							
					3 M.P.H.		4 M.P.H.		5M.P.H.		7 M.P.H.	
					15° SPRAY BAND	30° ROW SPACING	15° SPRAY BAND	30° ROW SPACING	15° SPRAY BAND	30° ROW SPACING	15° SPRAY BAND	30° ROW SPACING
ORANGE	8001E (100 Mesh)	20	.07	9	9.3	4.7	7.0	3.5	5.6	2.8	4.0	2.0
	30	.09	12	11.4	5.7	8.6	4.3	6.9	3.4	4.9	2.4	
	40	.10	13	13.2	6.6	9.9	4.9	7.9	4.0	5.7	2.8	
GREEN	80015E (100 Mesh)	20	.11	14	14.0	7.0	10.5	5.3	8.4	4.2	6.0	3.0
	30	.13	17	17.1	8.6	12.9	6.4	10.3	5.1	7.3	3.7	
	40	.15	19	19.8	9.9	14.8	7.4	11.9	5.9	8.5	4.2	
YELLOW	8002E (50 Mesh)	20	.14	18	18.7	9.3	14.0	7.0	11.2	5.6	8.0	4.0
	30	.17	22	23	11.4	17.1	8.6	13.7	6.9	9.8	4.9	
	40	.20	26	26	13.2	19.8	9.9	15.8	7.9	11.3	5.7	
BLUE	8003E (50 Mesh)	20	.21	27	28	14.0	21	10.5	16.0	8.4	12.0	6.0
	30	.26	33	34	17.1	26	12.9	21	10.3	14.7	7.3	
	40	.30	38	40	19.8	30	14.8	24	11.9	17.0	8.5	
RED	8004E (50 Mesh)	20	.28	36	37	18.7	28	14.0	22	11.2	16.0	8.0
	30	.35	45	46	23	34	17.1	27	13.7	19.6	9.8	
	40	.40	51	53	26	40	19.8	32	15.8	23	11.3	
BROWN	8005E (50 Mesh)	20	.35	45	47	23	35	17.5	28	14.0	20	10.0
	30	.43	55	57	29	43	21	34	17.1	24	12.2	
	40	.50	64	66	33	49	25	40	19.8	28	14.1	
GRAY	8006E (50 Mesh)	20	.42	54	56	28	42	21	34	16.8	24	12.0
	30	.52	67	69	34	51	26	41	21	29	14.7	
	40	.60	77	79	40	59	30	48	24	34	17.0	
WHITE	8008E (50 Mesh)	20	.57	73	75	37	56	28	45	22	32	16.0
	30	.69	88	91	46	69	34	55	27	39	19.6	
	40	.80	102	106	53	79	40	63	32	45	23	

\*Gallons Per Acre: (15° SPRAY BAND) GPA application rate on the spray band itself. (30° ROW SPACING) Total gallons used after driving over an actual field acre.



# TEEJET SPRAY TIPS

## FloodJet® Wide Angle Flat Spray Tips

Tip Size

TK-BRASS

TK-SS STAINLESS STEEL

TK-VS STAIN STEEL/VISIFLO

**How to order:** Specify tip number.

Examples:

- TK-VS5 – Stainless Steel with VisiFlo® color-coding
- TK-VP3 – Polymer with VisiFlo color-coding
- (B)1/4K-5 – Brass
- TK-SS5 – Stainless Steel
- (B)1/8K-SS5 – Stainless Steel
- QCK-SS100 – Stainless Steel with VisiFlo color-coding



(3/8" - 1" NPT)

Tip	PSI	CAPACITY ONE NOZZLE IN GPM	GPA $\Delta$ 40°												
			4 MPH	5 MPH	6 MPH	8 MPH	10 MPH	12 MPH	15 MPH	20 MPH					
1/8K-.50	10	0.050	—	—	—	—	—	—	—	—	—	—	—	—	—
TK-.50 (100)	20	0.071	2.6	2.1	1.8	1.3	1.1	0.88	0.70	0.53					
	30	0.087	3.2	2.6	2.2	1.6	1.3	1.1	0.86	0.65					
	40	0.10	3.7	3.0	2.5	1.9	1.5	1.2	0.99	0.74					
1/8K-.75	10	0.075	2.8	2.2	1.9	1.4	1.1	0.93	0.74	0.56					
TK-.75 (100)	20	0.11	4.1	3.3	2.7	2.0	1.6	1.4	1.1	0.82					
	30	0.13	4.8	3.9	3.2	2.4	1.9	1.6	1.3	0.97					
	40	0.15	5.6	4.5	3.7	2.8	2.2	1.9	1.5	1.1					
1/8K-1	10	0.10	3.7	3.0	2.5	1.9	1.5	1.2	0.99	0.74					
TK-1 (100)	20	0.14	5.2	4.2	3.5	2.6	2.1	1.7	1.4	1.0					
	30	0.17	6.3	5.0	4.2	3.2	2.5	2.1	1.7	1.3					
	40	0.20	7.4	5.9	5.0	3.7	3.0	2.5	2.0	1.5					
1/8K-1.5	10	0.15	5.6	4.5	3.7	2.8	2.2	1.9	1.5	1.1					
TK-1.5 (50)	20	0.21	7.8	6.2	5.2	3.9	3.1	2.6	2.1	1.6					
	30	0.26	9.7	7.7	6.4	4.8	3.9	3.2	2.6	1.9					
	40	0.30	11.1	8.9	7.4	5.6	4.5	3.7	3.0	2.2					
1/8K, 1/4K, TK]-2	10	0.20	7.4	5.9	5.0	3.7	3.0	2.5	2.0	1.5					
TK-2 (50)	20	0.28	10.4	8.3	6.9	5.2	4.2	3.5	2.8	2.1					
	30	0.35	13.0	10.4	8.7	6.5	5.2	4.3	3.5	2.6					
	40	0.40	14.9	11.9	9.9	7.4	5.9	5.0	4.0	3.0					
1/8K, 1/4K, TK]-2.5	10	0.25	9.3	7.4	6.2	4.6	3.7	3.1	2.5	1.9					
TK-2.5 (50)	20	0.35	13.0	10.4	8.7	6.5	5.2	4.3	3.5	2.6					
	30	0.43	16.0	12.8	10.6	8.0	6.4	5.3	4.3	3.2					
	40	0.50	18.6	14.9	12.4	9.3	7.4	6.2	5.0	3.7					
1/8K, 1/4K, TK]-3	10	0.30	11.1	8.9	7.4	5.6	4.5	3.7	3.0	2.2					
TK]-3 (50)	20	0.42	15.6	12.5	10.4	7.8	6.2	5.2	4.2	3.1					
	30	0.52	19.3	15.4	12.9	9.7	7.7	6.4	5.1	3.9					
	40	0.60	22	17.8	14.9	11.1	8.9	7.4	5.9	4.5					
1/8K, TK]-4 (50)	10	0.40	14.9	11.9	9.9	7.4	5.9	5.0	4.0	3.0					
TK-4 (50)	20	0.57	21	16.9	14.1	10.6	8.5	7.1	5.6	4.2					
	30	0.69	26	20	17.1	12.8	10.2	8.5	6.8	5.1					
	40	0.80	30	24	19.8	14.9	11.9	9.9	7.9	5.9					
1/8K, 1/4K, TK]-5	10	0.50	18.6	14.9	12.4	9.3	7.4	6.2	5.0	3.7					
TK]-5 (50)	20	0.71	26	21	17.6	13.2	10.5	8.8	7.0	5.3					
	30	0.87	32	26	22	16.1	12.9	10.8	8.6	6.5					
	40	1.00	37	30	25	18.6	14.9	12.4	9.9	7.4					
1/8K, 1/4K, TK]-7.5	10	0.75	28	22	18.6	13.9	11.1	9.3	7.4	5.6					
TK-7.5 (50)	20	1.06	39	31	26	19.7	15.7	13.1	10.5	7.9					
	30	1.30	48	39	32	24	19.3	16.1	12.9	9.7					
	40	1.50	56	45	37	28	22	18.6	14.9	11.1					
1/8K, 1/4K, TK]-10	10	1.00	37	30	25	18.6	14.9	12.4	9.9	7.4					
TK-10 (50)	20	1.41	52	42	35	26	21	17.4	14.0	10.5					
	30	1.73	64	51	43	32	26	21	17.1	12.8					
	40	2.00	74	59	50	37	30	25	19.8	14.9					
1/8K, 1/4K]-12	10	1.20	45	36	30	22	17.8	14.9	11.9	8.9					
	20	1.70	63	50	42	32	25	21	16.8	12.6					
	30	2.08	77	62	51	39	31	26	21	15.4					
	40	2.40	89	71	59	45	36	30	24	17.8					
1/8K, 1/4K]-15 TK-15	10	1.50	56	45	37	28	22	18.6	14.9	11.1					
	20	2.12	79	63	52	39	31	26	21	15.7					
	30	2.60	97	77	64	48	39	32	26	19.3					
	40	3.00	111	89	74	56	45	37	30	22					
1/8K, 1/4K]-18	10	1.80	67	53	45	33	27	22	17.8	13.4					
	20	2.55	95	76	63	47	38	32	25	19					
	30	3.12	116	93	77	58	46	39	31	23					
	40	3.60	134	107	89	67	53	45	36	27					
1/8K, 1/4K]-20	10	2.00	74	59	50	37	30	25	19.8	14.9					
TK-20	20	2.83	105	84	70	53	42	35	28	21					
QCK-20	30	3.46	128	103	86	64	51	43	34	26					
	40	4.00	149	119	99	74	59	50	40	30					
1/4K-22	10	2.20	82	65	54	41	33	27	22	16.3					
	20	3.11	115	92	77	58	46	38	31	23					
	30	3.81	141	113	94	71	57	47	38	28					
	40	4.40	163	131	109	82	65	54	44	33					
1/4K-24	10	2.40	89	71	59	45	36	30	24	17.8					
	20	3.39	126	101	84	63	50	42	34	25					
	30	4.16	154	124	103	77	62	51	41	31					
	40	4.80	178	143	119	89	71	59	48	36					

Tip	PSI	CAPACITY ONE NOZZLE IN GPM	GPA $\Delta$ 60°												
			4 MPH	5 MPH	6 MPH	8 MPH	10 MPH	12 MPH	15 MPH	20 MPH					
1/4K-27	10	2.70	67	53	45	33	27	22	17.8	13.4					
	20	3.82	95	76	63	47	38	32	25	18.9					
	30	4.68	116	93	77	58	46	39	31	23					
	40	5.40	134	107	89	67	53	45	36	27					
3/8K-30 TK-30	10	3.00	74	59	50	37	30	25	19.8	14.9					
	20	4.24	105	84	70	52	42	35	28	21					
QCK-30	30	5.20	129	103	86	64	51	43	34	26					
	40	6.00	149	119	99	74	59	50	40	30					
3/8K-35	10	3.50	87	69	58	43	35	29	23	17.3					
	20	4.95	123	98	82	61	49	41	33	25					
	30	6.06	150	120	100	75	60	50	40	30					
	40	7.00	173	139	116	87	69	58	46	35					
[3/8K, 1/2K]-40	10	4.00	99	79	66	50	40	33	26	19.8					
QCK-40	20	5.66	140	112	93	70	56	47	37	28					
	30	6.93	172	137	114	86	69	57	46	34					
	40	8.00	198	158	132	99	79	66	53	40					
3/8K-45	10	4.50	111	89	74	56	45	37	30	22					
	20	6.36	157	126	105	79	63	52	42	31					
	30	7.79	193	154	129	96	77	64	51	39					
	40	9.00	223	178	149	111	89	74	59	45					
1/2K-50	10	5.00	124	99	83	62	50	41	33	25					
QCK-50	20	7.07	175	140	117	87	70	58	47	35					
	30	8.66	214	171	143	107	86	71	57	43					
	40	10.0	248	198	165	124	99	83	66	50					
1/2K-60	10	6.00	149	119	99	74	59	50	40	30					
	20	8.49	210	168	140	105	84	70	56	42					
QCK-60	30	10.4	257	206	171	129	103	86	69	51					
	40	12.0	297	238	198	149	119	99	79	59					
1/2K-70	10	7.00	173	139	116	87	69	58	46	35					
	20	9.90	245	196	163	123	98	82	65	49					
	30	12.1	300	240	200	150	120	100	80	60					
	40	14.0	347	277	231	173	139	116	92	69					
[1/2K, 3/4K]-80	10	8.00	198	158	132	99	79	66	53	40					
QCK-80	20	11.3	280	224	186	140	112	93	75	56					
	30	13.9	344	275	229	172	138	115	9						

# TEEJET SPRAY TIPS

## TeeJet® Disc-Core Type Cone Spray Tips

For spraying pesticides at higher pressures and flow rates. Especially suitable for wettable powders and other abrasive chemicals. Larger capacity nozzles are also used in air blast sprayers.

- Produce smaller droplets for thorough coverage with contact pesticides and foliar applications.
- Maximum spray pressure to 300 PSI (20 bar).

### Typical Assembly with Ceramic Disc and Core



### Orifice Discs

Available in a variety of sizes and materials. Ceramic for increased wear life, hardened stainless steel, stainless steel and polymer.



### Ceramic Sizes Available:

DCER-2 through DCER-8, DCER-10.

NOZZLE IN GPM	PSI	CAPACITY ONE NOZZLE IN OZ./MIN.	GPA									
			4 MPH	5 MPH	6 MPH	8 MPH	10 MPH	12 MPH	15 MPH	20 MPH		
D2	DC13	40	0.08	10	5.9	4.8	4.0	3.0	2.4	2.0	1.6	1.2
		60	0.10	13	7.4	5.9	5.0	3.7	3.0	2.5	2.0	1.5
		80	0.11	14	8.2	6.5	5.4	4.1	3.3	2.7	2.2	1.6
		100	0.12	15	8.9	7.1	5.9	4.5	3.6	3.0	2.4	1.8
		150	0.14	18	10.4	8.3	6.9	5.2	4.2	3.5	2.8	2.1
D3	DC13	40	0.09	12	6.7	5.3	4.5	3.3	2.7	2.2	1.8	1.3
		60	0.11	14	8.2	6.5	5.4	4.1	3.3	2.7	2.2	1.6
		80	0.12	15	8.9	7.1	5.9	4.5	3.6	3.0	2.4	1.8
		100	0.13	17	9.7	7.7	6.4	4.8	3.9	3.2	2.6	1.9
		150	0.16	20	11.9	9.5	7.9	5.9	4.8	4.0	3.2	2.4
D4	DC13	40	0.12	15	8.9	7.1	5.9	4.5	3.6	3.0	2.4	1.8
		60	0.14	18	10.4	8.3	6.9	5.2	4.2	3.5	2.8	2.1
		80	0.16	20	11.9	9.5	7.9	5.9	4.8	4.0	3.2	2.4
		100	0.17	22	12.6	10.1	8.4	6.3	5.0	4.2	3.4	2.5
		150	0.20	26	14.9	11.9	9.9	7.4	5.9	5.0	4.0	3.0
D2	DC23	40	0.10	13	7.4	5.9	5.0	3.7	3.0	2.5	2.0	1.5
		60	0.13	17	9.7	7.7	6.4	4.8	3.9	3.2	2.6	1.9
		80	0.14	18	10.4	8.3	6.9	5.2	4.2	3.5	2.8	2.1
		100	0.16	20	11.9	9.5	7.9	5.9	4.8	4.0	3.2	2.4
		150	0.19	24	14.1	11.3	9.4	7.1	5.6	4.7	3.8	2.8
D3	DC23	40	0.12	15	8.9	7.1	5.9	4.5	3.6	3.0	2.4	1.8
		60	0.14	18	10.4	8.3	6.9	5.2	4.2	3.5	2.8	2.1
		80	0.16	20	11.9	9.5	7.9	5.9	4.8	4.0	3.2	2.4
		100	0.18	23	13.4	10.7	8.9	6.7	5.3	4.5	3.6	2.7
		150	0.21	27	15.6	12.5	10.4	7.8	6.2	5.2	4.2	3.1
D4	DC23	40	0.15	19	11.1	8.9	7.4	5.6	4.5	3.7	3.0	2.2
		60	0.19	24	14.1	11.3	9.4	7.1	5.6	4.7	3.8	2.8
		80	0.21	27	15.6	12.5	10.4	7.8	6.2	5.2	4.2	3.1
		100	0.23	29	17.1	13.7	11.4	8.5	6.8	5.7	4.6	3.4
		150	0.28	36	21	16.6	13.9	10.4	8.3	6.9	5.5	4.2
D5	DC23	40	0.18	23	13.4	10.7	8.9	6.7	5.3	4.5	3.6	2.7
		60	0.22	28	16.3	13.1	10.9	8.2	6.5	5.4	4.4	3.3
		80	0.25	32	18.6	14.9	12.4	9.3	7.4	6.2	5.0	3.7
		100	0.28	36	21	16.6	13.9	10.4	8.3	6.9	5.5	4.2
		150	0.34	44	25	20	16.8	12.6	10.1	8.4	6.7	5.0
D2	DC25	40	0.16	20	11.9	9.5	7.9	5.9	4.8	4.0	3.2	2.4
		60	0.19	24	14.1	11.3	9.4	7.1	5.6	4.7	3.8	2.8
		80	0.22	28	16.3	13.1	10.9	8.2	6.5	5.4	4.4	3.3
		100	0.25	32	18.6	14.9	12.4	9.3	7.4	6.2	5.0	3.7
		150	0.29	37	22	22	17.2	14.4	10.8	8.6	7.2	5.7
D3	DC25	40	0.19	24	14.1	11.3	9.4	7.1	5.6	4.7	3.8	2.8
		60	0.23	29	17.1	13.7	11.4	8.5	6.8	5.7	4.6	3.4
		80	0.26	33	19.3	15.4	12.9	9.7	7.7	6.4	5.1	3.9
		100	0.29	37	22	17.2	14.4	10.8	8.6	7.2	5.7	4.3
		150	0.35	45	26	21	17.3	13.0	10.4	8.7	7.2	5.7
D4	DC25	40	0.23	29	17.1	13.7	11.4	8.5	6.8	5.7	4.6	3.4
		60	0.35	45	26	21	17.3	13.0	10.4	8.7	7.2	5.7
		80	0.40	51	30	24	19.8	14.9	11.9	9.9	7.9	5.9
		100	0.45	58	33	27	22	16.7	13.4	11.1	8.9	6.7
		150	0.54	69	40	32	27	20	16.0	13.4	10.7	8.0
D5	DC25	40	0.35	45	26	21	17.3	13.0	10.4	8.7	6.9	5.2
		60	0.42	54	31	25	21	15.6	12.5	10.4	8.3	6.2
		80	0.48	61	36	29	24	17.8	14.3	11.9	9.5	7.1
		100	0.54	69	40	32	27	20	16.0	13.4	10.7	8.0
		150	0.65	83	48	39	32	24	19.3	16.1	12.9	9.7
D2	DC45	40	0.20	26	14.9	11.9	9.9	7.4	5.9	5.0	4.0	3.0
		60	0.25	32	18.6	14.9	12.4	9.3	7.4	6.2	5.0	3.7
		80	0.28	36	21	16.6	13.9	10.4	8.3	6.9	5.5	4.2
		100	0.32	41	24	19.0	15.8	11.9	9.5	7.9	6.3	4.8
		150	0.38	49	28	23	18.8	14.1	11.3	9.4	7.5	5.6
D3	DC45	40	0.23	29	17.1	13.7	11.4	8.5	6.8	5.7	4.6	3.4
		60	0.28	36	21	16.6	13.9	10.4	8.3	6.9	5.5	4.2
		80	0.33	42	25	19.6	16.3	12.3	9.8	8.2	6.5	4.9
		100	0.36	46	27	21	17.8	13.4	10.7	8.9	7.1	5.3
		150	0.44	56	33	26	22	16.3	13.1	10.9	8.7	6.5
D4	DC45	40	0.36	46	27	21	17.8	13.4	10.7	8.9	7.1	5.3
		60	0.43	55	32	26	21	16.0	12.8	10.6	8.5	6.4
		80	0.50	64	37	30	25	18.6	14.9	12.4	9.9	7.4
		100	0.56	72	42	33	28	21	16.6	13.9	11.1	8.3
		150	0.68	87	50	40	34	25	20	16.8	13.5	10.1
D5	DC45	40	0.45	58	33	27	22	16.7	13.4	11.1	8.9	6.7
		60	0.55	70	41	33	27	20	16.3	13.6	10.9	8.2
		80	0.64	82	48	38	32	24	19.0	15.8	12.7	9.5
		100	0.71	91	53	42	35	26	21	17.6	14.1	10.5
		150	0.86	110	64	51	43	32	26	21	17.0	12.8

TO ORDER ORIFICE DISC ONLY, SPECIFY DISC NUMBER MATERIAL.

Part #	Description
DCER-*	Ceramic
D*	Hardened Stainless Steel
DE*	Stainless Steel
DVP-*	Polymer

TO ORDER CORE ONLY, SPECIFY CORE NUMBER MATERIAL.

Part #	Description
DC*-CER	Ceramic
DC*-HSS	Hardened Stainless Steel
DC*-AL	Aluminum
DC*	Brass
DC*-NY	Nylon



### Cores

Standard cores are made of brass. Also available in ceramic, hardened stainless steel, aluminum and Nylon. All cores, with the exception of ceramic, are made with rear "nibs". Be sure core is always placed with the nib facing the nozzle body.

### Ceramic Sizes Available:

DC13-CER, DC23-CER, DC25-CER, DC31-CER, DC33-CER, DC35-CER, DC45-CER, DC46-CER, DC56-CER.



**STRAINER NOTE:** For nozzles using orifice disc numbers 1, 1.5 and 2; or core numbers 31 and 33, slotted strainer number 4514-20 equivalent to 25 mesh screen size is required. For all other larger capacity discs and cores, slotted strainer number 4514-32 equivalent to 16 mesh screen size is required.

**Note:** Always double check your application rates. Tabulations are based on spraying water at 70°F (21°C).

# TEEJET SPRAY TIPS

## ConeJet® VisiFlo® Hollow Cone Spray Tips

Tip Size

TX-VS\*

For use with the 114445A Teelet cap



		GPM																	
		30 PSI	40 PSI	50 PSI	60 PSI	70 PSI	80 PSI	90 PSI	100 PSI	120 PSI	140 PSI	160 PSI	180 PSI	200 PSI	220 PSI	240 PSI	260 PSI	280 PSI	300 PSI
TX-VS1	100	0.015	0.017	0.018	0.020	0.021	0.022	0.023	0.024	0.026	0.028	0.030	0.031	0.032	0.034	0.035	0.036	0.037	0.038
		VF	VF	VF	VF	VF	VF	VF	VF	VF	VF	VF	VF	VF	VF	VF	VF	VF	VF
TX-VS2	100	0.029	0.033	0.037	0.040	0.043	0.045	0.047	0.050	0.054	0.058	0.061	0.064	0.067	0.070	0.073	0.075	0.078	0.080
		VF	VF	VF	VF	VF	VF	VF	VF	VF	VF	VF	VF	VF	VF	VF	VF	VF	VF
TX-VK3	100	0.044	0.050	0.055	0.060	0.064	0.068	0.071	0.075	0.081	0.086	0.092	0.096	0.101	0.105	0.109	0.113	0.117	0.120
		F	VF	VF	VF	VF	VF	VF	VF	VF	VF	VF	VF	VF	VF	VF	VF	VF	VF
TX-VK4	50	0.058	0.067	0.074	0.080	0.086	0.091	0.096	0.101	0.110	0.118	0.125	0.132	0.139	0.145	0.151	0.157	0.162	0.167
		F	VF	VF	VF	VF	VF	VF	VF	VF	VF	VF	VF	VF	VF	VF	VF	VF	VF
TX-VK6	50	0.088	0.100	0.111	0.120	0.129	0.137	0.145	0.152	0.165	0.177	0.188	0.199	0.208	0.218	0.226	0.235	0.243	0.251
		F	F	VF	VF	VF	VF	VF	VF	VF	VF	VF	VF	VF	VF	VF	VF	VF	VF
TX-VK8	50	0.116	0.133	0.148	0.162	0.174	0.186	0.196	0.207	0.225	0.243	0.259	0.274	0.288	0.301	0.314	0.326	0.338	0.349
		F	F	VF	VF	VF	VF	VF	VF	VF	VF	VF	VF	VF	VF	VF	VF	VF	VF
TX-VK10	50	0.145	0.167	0.185	0.202	0.218	0.232	0.246	0.258	0.282	0.303	0.323	0.342	0.360	0.376	0.392	0.408	0.422	0.437
		F	F	F	F	VF	VF	VF	VF	VF	VF	VF	VF	VF	VF	VF	VF	VF	VF
TX-VK12	50	0.174	0.200	0.223	0.243	0.261	0.279	0.295	0.310	0.338	0.364	0.388	0.410	0.432	0.452	0.471	0.489	0.507	0.524
		F	F	F	F	VF	VF	VF	VF	VF	VF	VF	VF	VF	VF	VF	VF	VF	VF
TX-VK18	50	0.260	0.300	0.335	0.367	0.396	0.423	0.449	0.473	0.517	0.558	0.597	0.633	0.667	0.699	0.730	0.759	0.788	0.815
		F	F	F	F	F	F	VF	VF	VF	VF	VF	VF	VF	VF	VF	VF	VF	VF
TX-VK26	50	0.376	0.433	0.484	0.530	0.572	0.611	0.648	0.683	0.747	0.807	0.862	0.914	0.963	1.01	1.05	1.10	1.14	1.18
		F	F	F	F	F	F	VF	VF	VF	VF	VF	VF	VF	VF	VF	VF	VF	VF

Note: Always double check your application rates. Tabulations are based on spraying water at 70°F (21°C). See pages 281-293 for useful formulas and other information.

## WETBOOM STYLE BROADCAST NOZZLES

- Easily Convert Handgun Sprayer To A Broadcast Sprayer (3 GPM Minimum)
- Nozzle Assemblies Fit 5100316 Stainless Steel Tube
- Center Nozzle Assembly Inlet 1/2" Hose
- Shut-Off Valves Built Into Nozzle Assembly
- 30 Foot Total Swath
- Nozzle Assemblies Have Built In Swivel



Part #	Description
5275122	Polyacetal Left/Right Nozzle Assembly, 13' Coverage
5275123	Polyacetal Center Nozzle Assembly, 4' Coverage
5100316	Stainless Steel Tube

## XTENDER TIPS

Nozzle Size (MNPT)	Pressure (PSI)	Flow Rate (GPM)	Gallons per Acre at swath shown																Swath (Ft) at 40 PSI 48 in high
			MPH																
			4	5	6	8	10	12	15	20	2	3	4	5					
10 (1/4")	30	0.9	8.9	7.1	5.9	4.5	3.6	3.0	2.4	1.8	0.41	0.27	0.20	0.16			13		
	40	1.0	9.9	7.9	6.6	5.0	4.0	3.3	2.6	2.0	0.45	0.30	0.23	0.18					
	50	1.1	10.9	8.7	7.3	5.4	4.4	3.6	2.9	2.2	0.50	0.33	0.25	0.20					
15 (1/4")	30	1.2	11.9	9.5	7.7	5.9	4.8	4.0	3.2	2.4	0.55	0.36	0.27	0.22			14		
	40	1.3	10.9	8.7	7.3	5.4	4.4	3.6	2.9	2.2	0.53	0.35	0.26	0.21					
	50	1.5	12.5	10.0	8.3	6.3	5.0	4.2	3.4	2.5	0.61	0.41	0.30	0.24					
20 (1/4")	30	1.7	13.6	10.9	9.0	6.8	5.4	4.5	3.6	2.7	0.62	0.42	0.31	0.25			15		
	40	2.0	16.0	12.8	10.6	8.0	6.4	5.3	4.3	3.2	0.73	0.49	0.37	0.29					
	50	2.2	17.6	14.1	11.7	8.8	7.0	5.9	4.7	3.5	0.81	0.54	0.40	0.32					
24 (1/4")	30	2.4	19.2	15.3	12.8	9.6	7.7	6.4	5.1	3.8	0.88	0.59	0.44	0.35			16		
	40	2.1	16.2	13.0	10.8	8.1	6.5	5.4	4.3	3.2	0.75	0.50	0.37	0.30					
	50	2.4	18.6	14.9	12.4	9.3	7.4	6.2	5.0	3.7	0.85	0.57	0.43	0.34					
43 (3/8")	30	2.9	20.9	16.7	13.9	10.4	8.4	7.0	5.6	4.2	0.96	0.64	0.48	0.38			14		
	40	3.7	31.6	25.3	21.1	15.8	12.6	10.5	8.4	6.3	1.45	0.97	0.72	0.58					
	50	4.8	41.0	32.8	27.3	20.5	16.4	13.7	10.9	8.2	1.88	1.25	0.94	0.75					
80 (1/2")	30	5.3	45.2	36.2	30.2	22.6	18.1	15.1	12.1	9.0	2.08	1.38	1.04	0.83			13		
	40	6.9	68.3	54.6	45.5	34.2	27.3	22.8	18.2	13.7	3.14	2.09	1.57	1.25					
	50	8.0	79.2	63.4	52.8	39.6	31.7	26.4	21.1	15.8	3.64	2.42	1.82	1.45					
167 (3/4")	30	8.9	88.1	70.5	58.7	44.1	35.2	29.4	23.5	17.6	4.04	2.70	2.02	1.62			15		
	40	14.5	143.9	115.9	95.4	64.1	51.7	42.7	34.7	25.6	5.88	3.92	2.94	2.35					
	50	16.7	148	118	98.4	73.8	59.0	49.2	39.4	29.5	6.78	4.52	3.39	2.71					
215 (3/4")	30	18.7	165	132	110	82.6	66.1	55.1	44.1	33.1	7.59	5.06	3.79	3.03			16		
	40	20.5	181	145	121	90.6	72.5	60.4	48.3	36.2	8.32	5.54	4.16	3.33					
	50	18.6	144	115	95.9	71.9	57.5	48.0	38.4	28.8	6.60	4.40	3.30	2.64					
40	21.5	166	133	111	83.1	66.5	55.4	44.3	33.3	7.63	5.09	3.82	3.05						
50	24.0	186	149	124	92.8	74.3	61.9	49.5	37.1	8.52	5.68	4.26	3.41						
60	26.3	203	163	136	102	81.4	67.8	54.2	40.7	9.34	6.22	4.67	3.73						

Part #	Color
FC-XT010	GREEN
FC-XT020	BLUE
FC-XT024	YELLOW
FC-XT043	ORANGE

# TEEJET SPRAY TIPS



## TeeJet® Disc-Core Type Cone Spray Tips

**STRAINER NOTE** For nozzles using Orifice Disc Nos. 1, 1.5, and 2 or core Nos. 31 and 33. Slotted Strainer No. 4514-20 equivalent to 25 mesh screen size is required. For all other larger capacity Discs and cores. Slotted Strainer No. 4514-32 equivalent to 16 mesh screen size is required.



Full Cone Spray Pattern  
Produced By  
Cores #31,33,  
35, & 56

FULL CONE SPRAY PATTERN															
Orifice Desc. No.	Core No.	Orifice Diam.	CAPACITY GPM (Gallons Per Minute) at PSI (Pounds per Square Inch)										SPRAY ANGLE		
			10 PSI	20 PSI	30 PSI	40 PSI	60 PSI	80 PSI	100 PSI	150 PSI	200 PSI	300 PSI	20 PSI	40 PSI	80 PSI
D1	31	.031"	.08	.11	.13	.15	.18	.20	.23	.27	.31	.37	49°	47°	43°
D1.5	31	.036"	.10	.14	.17	.19	.23	.26	.29	.35	.40	.48	57°	65°	53°
D2	31	.041"	.12	.16	.19	.22	.26	.30	.33	.40	.45	.55	62°	63°	61°
D3	31	.047"	.13	.18	.21	.24	.29	.33	.37	.44	.50	.60	63°	65°	63°
D1	33	.031"	.09	.11	.12	.14	.17	.20	.22	.26	.30	.37	27°	32°	35°
D1.5	33	.036"	.12	.15	.17	.19	.23	.26	.30	.36	.41	.50	37°	43°	45°
D2	33	.041"	.13	.17	.21	.24	.29	.33	.37	.45	.52	.63	45°	52°	55°
D3	33	.047"	.15	.21	.25	.29	.36	.41	.45	.55	.63	.76	48°	54°	57°
D4	33	.063"	.20	.28	.34	.39	.47	.54	.60	.73	.83	1.02	50°	56°	61°
D1	35	.031"	.08	.11	.13	.14	.17	.20	.22	.26	.29	.35	19°	23°	26°
D1.5	35	.036"	.10	.14	.17	.19	.23	.26	.29	.34	.39	.46	23°	27°	29°
D2	35	.041"	.14	.18	.24	.25	.30	.34	.37	.45	.51	.60	40°	44°	47°
D3	35	.047"	.16	.22	.26	.30	.36	.41	.45	.55	.62	.74	45°	50°	52°
D4	35	.063"	.27	.37	.44	.50	.60	.70	.79	.93	1.1	1.3	68°	70°	71°
D5	35	.078"	.34	.48	.58	.66	.80	.92	1.0	1.2	1.4	1.7	67°	69°	71°
D2	56	.041"	—	—	.21	.25	.30	.35	.39	.47	.55	.67	—	14°	17°
D3	56	.047"	—	—	.29	.34	.41	.48	.53	.65	.75	.92	—	20°	23°
D4	56	.063"	—	.39	.48	.55	.67	.78	.87	1.06	1.23	1.51	20°	26°	29°
D5	56	.078"	.38	.54	.66	.76	.93	1.08	1.20	1.47	1.69	2.08	26°	32°	34°
D6	56	.094"	.55	.78	.95	1.10	1.35	1.55	1.74	2.13	2.46	3.02	34°	39°	41°
D7	56	.109"	.76	1.07	1.32	1.52	1.86	2.15	2.40	2.94	3.40	4.16	45°	52°	54°
D8	56	.125"	.96	1.36	1.67	1.93	2.36	2.73	3.05	3.73	4.32	5.28	52°	57°	59°
D10	56	.156"	1.35	1.91	2.34	2.70	3.31	3.82	4.26	5.22	6.03	7.39	62°	65°	67°

TYPE	SIZE	ORIFICE INSERT / TIP BODY MATERIAL	EXAMPLE TIP #
 <b>TeeJet®</b> ORIFICE DISCS	ALL SIZES	HARD. STAINLESS STEEL	D2
		STAINLESS STEEL	DE2
		CERAMIC	DCER-2
		POLYMER	DVP-2
 <b>TeeJet®</b> CORES	ALL SIZES	NYLON	DC23-NY
		BRASS	DC23
		HARD. STAINLESS STEEL	DC23-HSS
		CERAMIC	DC25-CER

# TEEJET SPRAY TIPS

## FieldJet® Boomless Nozzles with Extra-Wide Flat Spray Projection



Type 1/4 KLC and Type 3/4 KLC 1/4" NPT MALE and 3/4" NPT MALE pipe connections.

One-piece nozzle design, projects spray to both sides to form wide swath flat spray. Made in choice of brass, aluminum and stainless steel.

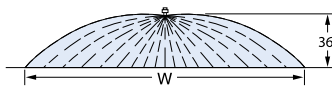

**How to order:**  
Specify part number and material.  
Example: 1/4KLC-SS18 – Stainless Steel

### Tip Size

1/4KLC Brass

1/4KLC-SS Stainless Steel

3/4KLC Brass

3/4KLC-SS Stainless Steel

FieldJet Nozzle No.	Liquid Press In PSI	Capacity in GPM	"W" Feet	GALLONS PER ACRE					
				4 M.P.H.	5 M.P.H.	7.5 M.P.H.	10 M.P.H.	15 M.P.H.	20 M.P.H.
1/4KLC-5	20	.7	17	5.2	4.1	2.8	2.1	1.4	1.0
	30	.9	18	6.0	4.8	3.2	2.4	1.6	1.2
	40	1.0	21	5.9	4.7	3.1	2.3	1.5	1.1
1/4KLC-9	20	1.3	18	8.8	7.0	4.7	3.5	2.3	1.8
	30	1.6	19	10.1	8.1	5.4	4.1	2.7	2.0
	40	1.8	21	10.6	8.5	5.7	4.2	2.8	2.1
1/4KLC-18	20	2.5	20	15.5	12.4	8.3	6.2	4.1	3.1
	30	3.1	21	18.3	14.6	9.7	7.3	4.9	3.7
	40	3.6	22	20	16.2	10.8	8.1	5.4	4.1
1/4KLC-36	20	5.1	22	29	23	15.3	11.5	7.6	5.7
	30	6.3	24	32	26	17.1	12.9	8.6	6.4
	40	7.2	26	34	27	18.3	13.7	9.1	6.9
3/4KLC-50	20	7.1	23	38	30	20	15.2	10.1	7.6
	30	8.7	26	41	33	22	16.5	11.0	8.2
	40	10.0	28	44	35	24	17.7	11.8	8.8
3/4KLC-72	20	10.2	25	50	40	27	20	13.4	10.1
	30	12.5	29	53	43	28	21	14.2	10.6
	40	14.4	31	57	46	31	23	15.3	11.5
3/4KLC-108	20	15.2	28	67	54	36	27	17.9	13.4
	30	18.7	33	70	56	37	28	18.7	14.0
	40	21.6	36	74	59	40	30	19.8	14.9

## BoomJet® Boomless Nozzles with Extra-Wide Flat Spray Projection

Type 5880 BoomJet and 5430 BoomJet Nozzles combine two off-center tips and three VeeJet nozzles to produce an overall wide swath flat spray. Nozzle assembly provides good distribution for the wide pattern coverage obtained. Supplied with one additional 1/4" NPT pipe plug and one blank tip for setting BoomJet to spray to one side only. Type 5880 also has a 1/4" NPT pressure gauge port.



W = Maximum effective coverage with nozzle mounted at 36" height.



TYPE 5880 - 3/4" NPT FEMALE back inlet connection.  
WEIGHTS: Brass 2 POUNDS



TYPE 5430 - 3/4" NPT FEMALE top inlet connection.  
WEIGHTS: Brass 2-1/2 pounds

### COMPLETE BOOMJETS

5880-3/4-2TOC

5430-3/4-2TOC

### OFFCENTER BRASS TIPS ONLY

6733-OC06

OC-10

OC-20

OC-40

Fimco CODE NO.	BoomJet NOZZLE NO.	OC TIPS (Two)	VeeJet Top Nozzles (Two)	VeeJet Bottom Nozzle	Liquid Pressure p.s.i.	Total Capacity G.P.M.	"W" Feet	GALLONS PER ACRE				
								4 M.P.H.	5 M.P.H.	7.5 M.P.H.	10 M.P.H.	15 M.P.H.
5138554 5138557	5880-3/4-2TOC06 5430-3/4-2TOC06	6733-OC06	H1/4VV-1506	H1/4VVL-9502 with 50 mesh strainer	20	1.8	33-1/2	6.8	5.4	3.5	2.7	1.8
					30	2.3	34	8.2	6.6	4.4	3.3	2.2
					40	2.6	34-1/2	9.3	7.5	5.0	3.7	2.5
5138475 5138539	5880-3/4-2TOC10 5430-3/4-2TOC10	OC-10	H1/4U-0508HE	H1/4VVL-11004 with 50 mesh strainer	20	2.8	39-1/2	8.9	7.1	4.7	3.5	2.4
					30	3.5	40	10.7	8.6	5.7	4.3	2.9
					40	4.0	40-1/2	12.2	9.8	6.5	4.9	3.3
5138555 5138558	5880-3/4-2TOC20 5430-3/4-2TOC20	OC-20	H1/4U-0520HE	H1/4VVL-9506 with 50 mesh strainer	20	6.1	47	16.0	12.8	8.5	6.4	4.3
					30	7.4	50	18.4	14.7	9.8	7.4	4.9
					40	8.6	52	20	16.4	10.9	8.2	5.5
5138556 5138559	5880-3/4-2TOC40 5430-3/4-2TOC40	OC-40	H1/4U-0540HE	H1/4U-9510	20	12.0	56	27	21	14.2	10.6	7.1
					30	14.7	60	30	24	16.2	12.1	8.1
					40	17.0	63	33	27	17.8	13.4	8.9

## OFF-CENTER FLAT SPRAY TIPS - SMALLER CAPACITIES

TeeJet Off-Center spray tips are commonly installed in double and single swivel nozzle bodies. Because these bodies are adjustable for angular position, a wide spray swath is easily obtained.

### Extra Wide Flat Spray Coverage

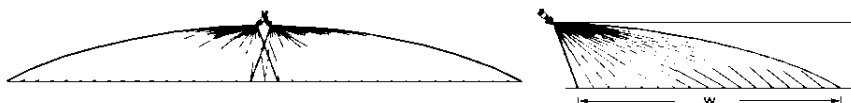

Part #	Description
OC	Brass Off Center Tip
OC-SS	Stainless Steel Off Center Tip

FieldJet Nozzle No.	Liquid Press In PSI	Capacity in GPM	SPRAYING HEIGHT "H" = 18"				SPRAYING HEIGHT "H" = 24"			
			"W" in Inches	GALLONS PER ACRE*			"W" in Inches	GALLONS PER ACRE*		
				3 M.P.H	4 M.P.H	5 M.P.H		3 M.P.H	4 M.P.H	5 M.P.H
OC-02	30	.17	68	4.9	3.7	3.0	75	4.5	3.4	2.7
	40	.20	70	5.6	4.2	3.4	77	5.1	3.9	3.1
	60	.25	72	6.9	5.1	4.1	78	6.3	4.7	3.8
OC-03	30	.26	77	6.7	5.0	4.0	80	6.4	4.8	3.9
	40	.30	80	7.5	5.6	4.5	83	7.1	5.3	4.3
	60	.37	82	8.9	6.7	5.3	85	8.6	6.3	5.2
OC-04	30	.35	91	7.6	5.7	4.6	93	7.4	5.6	4.5
	40	.40	93	8.5	6.4	5.1	94	8.4	6.3	5.1
	60	.49	94	10.5	7.7	6.2	95	10.2	7.6	6.1
OC-06	30	.52	99	10.4	7.8	6.2	108	9.5	7.1	5.7
	40	.60	101	11.7	8.8	7.0	110	10.8	8.1	6.5
	60	.73	102	14.2	10.6	8.5	111	13.0	9.8	7.8
OC-08	30	.69	100	13.6	10.2	8.2	110	12.4	9.3	7.4
	40	.80	102	15.5	11.6	9.3	112	14.1	10.6	8.5
	60	.98	104	18.6	14.0	11.2	113	17.2	12.9	10.4
OC-12	30	1.0	102	20	15.1	12.1	113	18.2	13.7	10.9
	40	1.2	104	23	17.1	13.7	115	21	15.5	12.4
	60	1.5	105	28	21	16.6	116	25	18.8	15.1
OC-16	30	1.4	132	21	15.7	12.5	142	19.4	14.6	11.6
	40	1.6	138	23	17.2	13.8	146	22	16.3	13.0
	60	2.0	143	27	20	16.2	148	26	19.7	15.7

\* Gallons Per Acre coverage is based on water.

# TEEJET SPRAY TIPS

## FieldJet® Boomless Nozzles with Extra-Wide Flat Spray Projection



Type 1/4 KLC and Type 3/4 KLC 1/4" NPT MALE and 3/4" NPT MALE pipe connections.

One-piece nozzle design, projects spray to both sides to form wide swath flat spray. Made in choice of brass, aluminum and stainless steel.

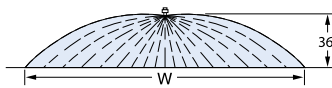

**How to order:**  
Specify part number and material.  
Example: 1/4KLC-SS18 – Stainless Steel

### Tip Size

1/4KLC Brass

1/4KLC-SS Stainless Steel

3/4KLC Brass

3/4KLC-SS Stainless Steel

FieldJet Nozzle No.	Liquid Press In PSI	Capacity in GPM	"W" Feet	GALLONS PER ACRE					
				4 M.P.H.	5 M.P.H.	7.5 M.P.H.	10 M.P.H.	15 M.P.H.	20 M.P.H.
1/4KLC-5	20	.7	17	5.2	4.1	2.8	2.1	1.4	1.0
	30	.9	18	6.0	4.8	3.2	2.4	1.6	1.2
	40	1.0	21	5.9	4.7	3.1	2.3	1.5	1.1
1/4KLC-9	20	1.3	18	8.8	7.0	4.7	3.5	2.3	1.8
	30	1.6	19	10.1	8.1	5.4	4.1	2.7	2.0
	40	1.8	21	10.6	8.5	5.7	4.2	2.8	2.1
1/4KLC-18	20	2.5	20	15.5	12.4	8.3	6.2	4.1	3.1
	30	3.1	21	18.3	14.6	9.7	7.3	4.9	3.7
	40	3.6	22	20	16.2	10.8	8.1	5.4	4.1
1/4KLC-36	20	5.1	22	29	23	15.3	11.5	7.6	5.7
	30	6.3	24	32	26	17.1	12.9	8.6	6.4
	40	7.2	26	34	27	18.3	13.7	9.1	6.9
3/4KLC-50	20	7.1	23	38	30	20	15.2	10.1	7.6
	30	8.7	26	41	33	22	16.5	11.0	8.2
	40	10.0	28	44	35	24	17.7	11.8	8.8
3/4KLC-72	20	10.2	25	50	40	27	20	13.4	10.1
	30	12.5	29	53	43	28	21	14.2	10.6
	40	14.4	31	57	46	31	23	15.3	11.5
3/4KLC-108	20	15.2	28	67	54	36	27	17.9	13.4
	30	18.7	33	70	56	37	28	18.7	14.0
	40	21.6	36	74	59	40	30	19.8	14.9

## BoomJet® Boomless Nozzles with Extra-Wide Flat Spray Projection

Type 5880 BoomJet and 5430 BoomJet Nozzles combine two off-center tips and three VeeJet nozzles to produce an overall wide swath flat spray. Nozzle assembly provides good distribution for the wide pattern coverage obtained. Supplied with one additional 1/4" NPT pipe plug and one blank tip for setting BoomJet to spray to one side only. Type 5880 also has a 1/4" NPT pressure gauge port.



W = Maximum effective coverage with nozzle mounted at 36" height.



TYPE 5880 - 3/4" NPT FEMALE back inlet connection.  
WEIGHTS: Brass 2 POUNDS



TYPE 5430 - 3/4" NPT FEMALE top inlet connection.  
WEIGHTS: Brass 2-1/2 pounds

### COMPLETE BOOMJETS

5880-3/4-2TOC

5430-3/4-2TOC

### OFFCENTER BRASS TIPS ONLY

6733-OC06

OC-10

OC-20

OC-40

Fimco CODE NO.	BoomJet NOZZLE NO.	OC TIPS (Two)	VeeJet Top Nozzles (Two)	VeeJet Bottom Nozzle	Liquid Pressure p.s.i.	Total Capacity G.P.M.	"W" Feet	GALLONS PER ACRE				
								4 M.P.H.	5 M.P.H.	7.5 M.P.H.	10 M.P.H.	15 M.P.H.
5138554 5138557	5880-3/4-2TOC06 5430-3/4-2TOC06	6733-OC06	H1/4VV-1506	H1/4VVL-9502 with 50 mesh strainer	20	1.8	33-1/2	6.8	5.4	3.5	2.7	1.8
					30	2.3	34	8.2	6.6	4.4	3.3	2.2
					40	2.6	34-1/2	9.3	7.5	5.0	3.7	2.5
5138475 5138539	5880-3/4-2TOC10 5430-3/4-2TOC10	OC-10	H1/4U-0508HE	H1/4VVL-11004 with 50 mesh strainer	20	2.8	39-1/2	8.9	7.1	4.7	3.5	2.4
					30	3.5	40	10.7	8.6	5.7	4.3	2.9
					40	4.0	40-1/2	12.2	9.8	6.5	4.9	3.3
5138555 5138558	5880-3/4-2TOC20 5430-3/4-2TOC20	OC-20	H1/4U-0520HE	H1/4VVL-9506 with 50 mesh strainer	20	6.1	47	16.0	12.8	8.5	6.4	4.3
					30	7.4	50	18.4	14.7	9.8	7.4	4.9
					40	8.6	52	20	16.4	10.9	8.2	5.5
5138556 5138559	5880-3/4-2TOC40 5430-3/4-2TOC40	OC-40	H1/4U-0540HE	H1/4U-9510	20	12.0	56	27	21	14.2	10.6	7.1
					30	14.7	60	30	24	16.2	12.1	8.1
					40	17.0	63	33	27	17.8	13.4	8.9

## TEEJET CALIBRATION CONTAINER AND CLEANING BRUSH



**CALIBRATION CONTAINER**



**TEEJET CLEANING BRUSH**

<u>FIMCO Part #</u>	<u>MFG Part #</u>	<u>Description</u>
5167037	CP24034A-PP	TeeJet Calibration Container
5167039	CP20016-NY	TeeJet Tip Cleaning Brush

## BRASS HANDGUN SWIVEL

- The 900 Swivel promotes a compact design for 3/8 NPT fluid hose and air line applications
- The 901 Swivel promotes a compact design for 1/2 NPT fluid hose and air line applications
- The 901 Swivel promotes a compact design for 1/4 NPT fluid hose and air line applications
- Maximum Operating Pressure - 1000 psi
- Bronze Thrust Bearing for low torque with a Buna-N seal is standard

<u>FIMCO Code #</u>	<u>Description</u>
5930190	3/8" SWIVEL 900-4F4M-F (Viton)
5960190	1/2" SWIVEL 901-8F8M-F (Viton)
6160190	1/4" SWIVEL 902-6F6M-F (Viton)



## No. 3056 ADAPTER

Attaches to outlet of No. 46 Trigger Valve, to convert valve to spray gun. Choice of 1/4", 3/8", and 1/2" NPT female outlet connections for attachment of nozzles or extensions.



## No. 11740B SWIVEL ADAPTER

Made with 3/4" garden hose thread connections to fit all GunJet Spray Guns above with similar size inlet connections. Provides free-Swiveling, leak-proof connections at pressures up to 800 psi.

<u>FIMCO Code #</u>	<u>MFG Part #</u>	<u>Description</u>
5005135	3056-1/2	1/2" Brass Adapter
5057090	11740B	3/4" Garden Hose Swivel Brass





# SPRAY WANDS

## SPRAYING SYSTEMS NO. AA18-AL

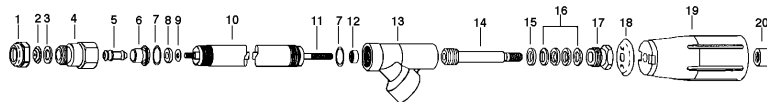

FIMCO Code #	MFG Part #	Description
5163021	AA18-AL6	20" Aluminum Gun

### HEAVY DUTY TYPE ROTATING HANDLE CONTROL

Handle rotates 360° to operate spray gun valve from shut-off to maximum flow position. As handle is turned, spray changes from initial cone spray through intermediate cone spray to straight stream. Corrosion and abrasion resistant hardened stainless steel interchangeable orifice discs. Discs may be purchased separately as desired. TeeJet Tips may also be used with these GunJets.

For Pressures: Up To 800 P.S.I.  
Overall length: 20"  
Weight: 1lbs.

Ref #	FIMCO Code #	MFG Part #	Description
1	5046033	CP1325-AL	Cap Alum
2	5063071	D6	Orifice Disc
*3	Available in Kit Only		Tip Gasket, Buna-N
4	5084050	CP5869-AL	Spray Housing, Alum
*5	Available in Kit Only		Core, Rivet & Core Body Sub-Asb., Alum-
6	5077030	CP5872-AL	Guide Sleeve, Alum
7	5072285	CP4143-CU	Gasket, Copper
*8	Available in Kit Only		Seat Plate, Nylon
*9	Available in Kit Only		Washer, Type 302 SS
10	5009278	CP5878-AL	Tubing, Alum
11	5132051	CP5879-AL	Stem, Alum
12	5006192	CP6618-AL	1/4-28 Nut, Alum
13	5002378	CP6896-AL	Inlet Body, Alum
14	5134023	CP5882-NP	Hand Grip Stud, Brass, Nickel plated
15	5016069	CP5883-AL	Packing Washer, Alum
16	5097031	CP5809-LEA	Packing, Thermo-Leather (4 Req'd)
17	5117068	CP5811-AL	Packing Screw, Alum
18	5016149	CP5884-INP	Hand Grip Collar, Steel, Nickel plated
19	5078112	CP5994-NY	Plastic Hand Grip, Nylon
20	5006070	CP5813-AL	Hand Grip Nut, Alum
*	5168368	PK-AB18-AL-KIT	Spare Parts Kit (Items Marked*)

## SPRAYING SYSTEMS NO. AA143-AL



GunJet No. 143-AL-GH--length 22-1/4". Weight 1 - 1/4 pounds, 3/4" Female garden hose thread inlet connection, aluminum.

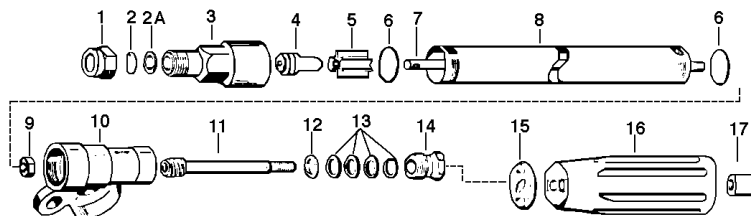

FIMCO Code #	MFG Part #	Description
5163014	AA143-AL-GH-6 Gun	3/4" GHT female garden hose connection

Handle rotates 360° to operate spray gun valve from shut-off to maximum flow position. As handle is turned, spray changes from initial cone spray through intermediate cone spray to straight stream. Corrosion and abrasion resistant hardened stainless steel interchangeable orifice discs. Discs may be purchased separately as desired. TeeJet Tips may also be used with these GunJets.

For Pressures: Up to 800 P.S.I.  
Overall length: 22-1/4"  
Weight: 1-1/4 lbs.

\*\* Parts necessary to replace handle on older guns

Ref #	FIMCO Code #	MFG Part #	Description
1	5046033	CP1325-AL	Cap
2	5063071	D6	Orifice Disc
*2A	Available in Kit Only		Gasket
3	5084016	CP10566-AL	Housing
*4	Available in Kit Only		Seat Plug
5		CP10571-3-NYB	Guide Vane
*6	Available in Kit Only		Gasket(2 Req'd)
7	5132007	CP10576-416SS	Stem
8	5009080	CP6604-AL	Tube
9	5006192	CP6618-AL	Nut
10	5002195	CP6898-GH-AL	Inlet Body (GH)
**11	5134023	CP5882-NP	Hand Grip Stud
12	5016069	CP5883-AL	Washer
*13	Available in Kit Only		Packing (4 Req'd)
14	5117068	CP5811-AL	Screw
**16	5078112	CP5994-NY	Nylon Hand Grip
**17	5006070	CP5813-AL	Hand Grip Nut
*	5168187	PK-AB143-AL-KIT	Kit Marked

# HIGH PRESSURE SPRAY WAND, HAND VALVE & TIP

## GUNJET NO.43 SPRAY WAND - HEAVY DUTY TRIGGER GUN



**TeeJet**  
TECHNOLOGIES

Add 5960190 (901 Swivel)  
For Easy Hose Maneuvering.

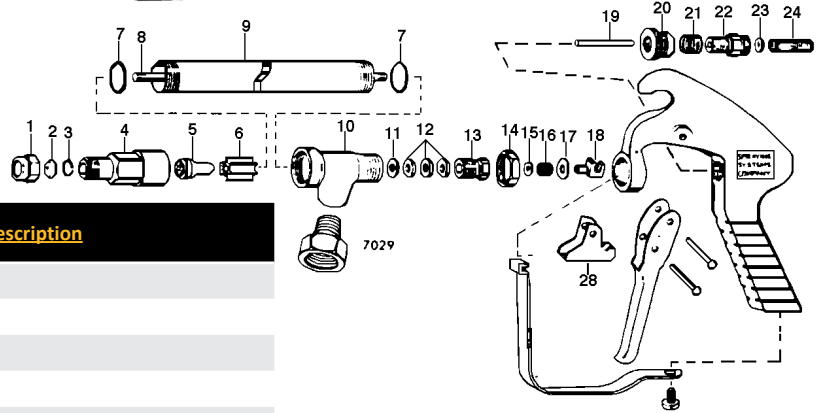

FIMCO Code #	MFG Part #	Description
5163006	AA43H-6	23" Brass Wand
5163005	AA43H-AL6	23" Aluminum Wand
5163007	AA43HA-6	14" Brass Wand
5163004	AA43HA-AL6	14" Aluminum Wand
5005119	(7029-AL) GHT(F) x 1/2" NPT(M)	Inlet Adapter w/Gasket, Aluminum for No. 43 Gunjets

Ref #	Description	BRASS GUN		ALUMINUM GUN	
		FIMCO Code #	MFG Part #	FIMCO Code #	MFG Part #
1	Cap	5046022	CP1325	5046033	CP1325-AL
2	Orifice Disc, Stainless Steel	5063071	D6	5063071	D6
*3	Orifice Disc, Stainless Steel	Available In Spare Parts Kit Only (Items Marked*)			
4	Nozzle Housing	5084023	CP10566	5084016	CP10566-AL
*5	Seat Plug, Assembly	Available In Spare Parts Kit Only (Items Marked*)			
6	Guide Vane	-	CP10571-2-NYB	-	CP10571-2-NYB
7	Gasket, Alum (2 Req'd)	5072172	CP6943-AL	5072172	CP6943-AL
8	Stem, Stainless Steel	5132039	CP19238-416SS	5132039	CP19238-416SS
9	Tubing (23")	5009120	CP6604	5009080	CP6604-AL
10	Inlet Body	5002204	CP6492	5002203	CP6492-AL
*11	Packing Washer	Available In Spare Parts Kit Only (Items Marked*)			
*12	Packing, (3 Req'd)	Available In Spare Parts Kit Only (Items Marked*)			
13	Packing Screw	5117164	CP19237	5117165	CP19237-AL
14	Locknut	5006063	CP6599	5006350	CP6599-NP
15	Stem Nut, Steel-Plated	5006244	CP9641-INP	5006244	CP9641-INP
16	Trigger Stop Spring	5019083	CP6595-SS	5019083	CP6595-SS
17	Washer	5016061	CP7991-IZP	5016061	CP7991-IZP
18	Trigger Guide	5166017	CP6597-INP	5166017	CP6597-INP
19	Spring Stud	5134010	CP6591-SS	5134010	CP6591-SS
20	Stop Adjusting Nut	5006072	CP6589-IZP	5006072	CP6589-IZP
21	Spring	5019069	CP6594-SS	5019069	CP6594-SS
22	Spring Screw	5117070	CP6588-IZP	5117070	CP6588-IZP
23	Guide Washer	5016071	CP6592-302SS	5016071	CP6592-302SS
24	Main Spring (For 43H)	5019107	CP6593-2-SS	5019107	CP6593-2-SS
28	Trigger Stop	5131012	CP6510-INP	5131012	CP6510-INP
	Spare Parts Kit (Item *)	5168370	PK-AB43-KIT	5168190	PK-AB43-AL-KIT

## HAND VALVE & CONEJET TIP



5138552 &  
5138553

FIMCO Code #	MFG Part #	Description	Connection	
			In	Out
5143155	AA36-1/4	Trigger Valve w / Lock	1/4 FNPT	1/4 FNPT
5002294	CP1322	Brass Male Nozzle Body	1/4 MNPT	Nozzle Body
5138552	5780-AX45	Brass Adjustable Cone Jet Tip	Fits Nozzle Body (1322)	
5138553	5780-AX60	Brass Adjustable Cone Jet Tip	Fits Nozzle Body (1322)	



5143155



5002294

# GUNJET SPRAY WANDS & ADJUSTABLE TIPS

## GUNJET NO. AA23L-7676

Maximum Pressure 250 PSI 23L-7676 with choice of 8", 18", 24", 36", and 48" Extensions Shut-Off Seat At Spray Tip End. Valve needle extends through length of extension

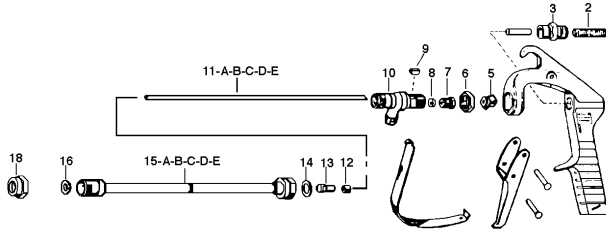

FIMCO Code #	MFG Part #	Extension Length
5163031	AA23L-7676-8"	Gunjet w/ 8" Extension
5163026	AA23L-7676-18"	Gunjet w/18" Extension
5163027	AA23L-7676-24"	Gunjet w/24" Extension
5163028	AA23L-7676-36"	Gunjet w/36" Extension
5163030	AA23L-7676-48"	Gunjet w/48" Extension

\*Price of Gun Does Not Include 5500 Tip as Shown In Picture. Order 5500 Tip, separately, as shown on the bottom of this page.

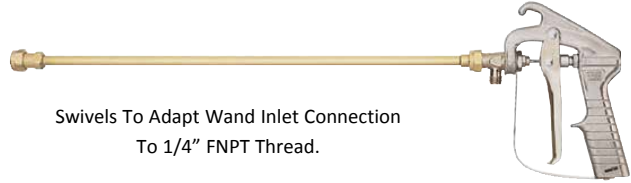

Swivels To Adapt Wand Inlet Connection To 1/4" FNPT Thread.

Ref #	FIMCO Code #	MFG Part #	Description
*2	Available In Kit Only		Spring, 302 Stainless Steel
3	5117065	CP7480-IZP	Spring Screw
5	5077029	CP8591-IZP	Trigger Guide
6	5006065	CP7486-IENP	Locknut, Steel Zinc Plated
7	5117137	CP16071-NP	Packing Screw
*8	Available In Kit Only		Cup Packing Buna-N
9	5089030	CP7892-IZP	Key
10	5002356	CP16052-NP	Inlet Body, Brass Nickel Plated
11A	5132040	CP7677-8-SS	Stem, Stainless Steel (For 8" Extension)
11B	5132041	CP7677-18-SS	Stem, Stainless Steel (For 18" Extension)
11D	5132043	CP7677-36-SS	Stem, Stainless Steel (For 36" Extension)
11E	5132044	CP7677-48-SS	Stem, Stainless Steel (For 48" Extension)
12	5132045	CP7679-1	Stem Guide
*13	Available In Kit Only		Stem end, brass
14	5072272	CP4743-TEF	Gasket Teflon
15A	5065014	7715-8	Extension, Brass (For 8" Length) Extension Assembly,
	5065030	13206-8	Brass (Incl. Items 11A, 12, 13, 14, & 15A) For 8" Length
15B	5065015	7715-18	Extension, Brass (For 18" Length) Extension Assembly,
	5065031	13206-18	Brass (Incl. Items 11B, 12, 13, 14, & 15B) For 18" Length
15C	5065016	7715-24	Extension, Brass (For 24" Length) Extension Assembly,
	5065032	13206-24	Brass (Incl. Items 11C, 12, 13, 14, 15C) For 24" Length
15D	5065018	7715-36	Extension, Brass (For 36" Length) Extension Assembly,
	5065033	13206-36	Brass (Incl. Items 11D, 12, 13, 14, & 15D) For 36" Length
15E	5065019	7715-48	Extension, Brass (For 48" Length) Extension Assembly,
	5065034D	13206-48	Brass (Incl. Items 11-E, 12, 13, 14, & 15E) For 48" Length
*16	5115025	CP7490-BRTF	Valve Seat Teflon
18	5046043	CP1325-NP	Cap, Brass Nickel Plated
*	5168244	AB23L-7676 -KIT	Spare Parts Kit Items Marked *
19	5057086	11990-10	Swivel 1/4 NPS x 1/4 FNPT Female
20	5010101		Connector 1/4 NPS x 1/4 FNPT (Does Not Swivel When Tight)

## ADJUSTABLE TIPS NO. 5500

Adjustable ConeJet Tip No.	Performance	Liquid Pressure in PSI											
		20 PSI		30 PSI		40 PSI		60 PSI		100 PSI		60 PSI	
		Setting	Setting	Setting	Setting	Setting	Setting	Setting	Setting	Setting	Setting	Setting	
5500-X2	Capacity-GPM	.025	.091	.03	.11	.033	.13	.04	.16	.05	.20	.058	.25
	Spray Angle	40°	—	60°	—	68°	—	75°	—	80°	—	83°	—
	Max. Throw Ft.	1.5	23	1.5	26	2	27	2	28	2	28	2	28
5500-X3 5500-PPB-X3	Capacity-GPM	.037	.13	.045	.17	.05	.19	.058	.23	.073	.30	.088	.37
	Spray Angle	57°	—	68°	—	72°	—	76°	—	80°	—	82°	—
	Max. Throw-Ft.	2	27	2	30	2	31	2	31	3	31	3	31
5500-X5 5500-PPB-X5	Capacity-GPM	.061	.21	.076	.26	.082	.30	.10	.37	.13	.48	.15	.58
	Spray Angle	61°	—	70°	—	74°	—	77°	—	80°	—	81°	—
	Max. Throw-Ft.	2.5	31	2.5	34	3	35	3	35	3	35	3	35
5500-X8 5500-PPB-X8	Capacity-GPM	.097	.33	.12	.40	.13	.47	.16	.57	.21	.74	.25	.90
	Spray Angle	66°	—	71°	—	74°	—	77°	—	80°	—	80°	—
	Max. Throw-Ft.	3	34	3	37	3	38	3	38	4	38	4	38

## POLYPROPYLENE OR BRASS



Adjustable ConeJet Tips fit standard TeeJet Spray Nozzle body. Body of No. 5500 rotates for spray selection from wide angle cone to straight stream. For capacities from .02 to .04 GPM at 40 p.s.i.

FIMCO Code #	MFG Part #	Description
5138543	5500-X2	Brass Adjustable Tip
5138544	5500-X3	Brass Adjustable Tip
5138564	5500-PPB-X3	Polypropylene Adjustable Tip
5138545	5500-X5	Brass Adjustable Tip
5138565	5500-PPB-X5	Polypropylene Adjustable Tip
5138453	5500-X8	Brass Adjustable Tip
5138566	5500-PPB-X8	Polypropylene Adjustable Tip
5138659	5500-X18	Brass Adjustable Tip
5138654	5500-PPB-X18	Polypropylene Adjustable Tip
5138661	5500-X26	Brass Adjustable Tip

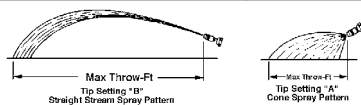





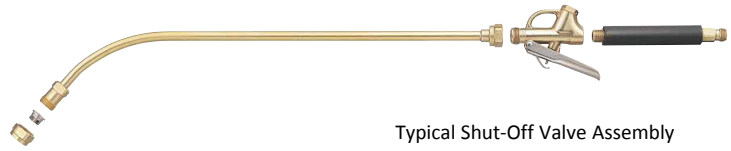

# SPRAY WANDS & SHUT-OFF VALVES

Top quality hand valves for use with spray nozzles, extensions and handles to suit your application needs. Hand valve assemblies may be made from parts shown on this page. The "typical assembly" shown at right includes 4727 handle, 4688 valve, 4673-8 curved extension with swivel body, TeeJet cap and flat spray tip.





Typical Shut-Off Valve Assembly

## TRIGGERS FOR SPRAY GUNS

	FIMCO Code #	MFG Part #	Description	Connection		Max Flow	Max Press	List Wt.
				In	Out			
	5143152	4688	Trigger Valve w/lock	1/4 FIPT	Tee Jet Cap	2 GPM	250	5 oz
	5143153	6466	Same as 4688 less Trigger lock w/extra long Handle	1/4 FIPT	Tee Jet Cap	2 GPM	250	5 oz
	5143154	6104	Trigger Valve w/lock	1/4 FIPT	1/4 FIPT	2 GPM	250	5 oz
	5143174	6590	Trigger Valve less lock	1/4 FIPT	1/4 FIPT	2 GPM	250	5 oz
	5143155	AA36-1/4	Trigger Valve w/lock	1/4 FIPT	1/4 FIPT	7 GPM	150	13 oz
	5143216	AA36-3/8	Trigger Valve w/lock	3/8 FIPT	3/8 FIPT	7 GPM	150	13 oz

## VALVE HANDLES

CHOICE OF VALVE HANDLES-for above valves. Outlet connections are 1/4" NPT(M) to fit 1/4" NPT (F) inlets of all valves shown. Choice of types for every need.

	5078102	4727	Brass Rubber Covered	1/4 MNPS	1/4 MIPT		4 1/4 oz.
	5078103	4754	Brass Rubber Covered	3/4 FGHT	1/4 MIPT		5 1/4 oz.
	5078152	4725	1/8" Brass Pipe w/Bushing Slip Hose over Pipe to form Handle	3/8" OD	1/4 MIPT		1 1/2 oz.

# EXTENSIONS & POLYPROPYLENE SPRAY WANDS

## EXTENSIONS FOR SPRAY Wands



FIMCO Code #	MFG Part #	Extension Length
5065014	7715-8	8"
5065015	7715-18	18"
5065016	7715-24	24"
5065017	7715-30	30"
5065018	7715-36	36"
5065019	7715-48	48"

**STRAIGHT WITH FIXED BODY (Pressure to 250 PSI)**

4673- for pressures to 125 P.S.I. 6671- & 7715- for pressures to 250 psi Fits Models 23L, 31 GunJet spray Guns and trigger valves. Designed for use with TeeJet strainers, caps, and spray tips.



CURVED WITH SWIVEL BODY (Pressure to 125 PSI)		
5065008	4673-8	8"
5065009	4673-18	18"
5065010	4673-24	24"
5065011	4673-30	30"
5065012	4673-36	36"
5065013	4673-48	48"

Use when spraying pressures will be greater than 250 P.S.I. Fits models 23H and 31 GunJet Spray Guns. Body designed for use with TeeJet strainers, caps and spray tips. Fixed position body, brass constructed with rubber covered handle (except in 8" length). Warning: Do not use at pressure higher than those specified for valve or spray gun.



CURVED WITH FIXED BODY (Pressure to 250 PSI)		
5065002	6671-8	8"
5065003	6671-18	18"
5065004	6671-24	24"
5065005	6671-30	30"
5065006	6671-36	36"
5065007	6671-48	48"



CURVED WITH HIGH PRESSURE (Pressure to 1000 PSI)		
5065022	9527-24	24"
5065023	9527-36	36"

## TRIGGERJET POLYPROPYLENE SPRAY GUNS

### AA30L-PP

- Inlet Is 1/4" FIPT
- Flow Rates to 5 G.P.M.
- Maximum Pressure 150 P.S.I.
- Wetted Parts Are Polypropylene
- Stainless Steel and Viton



### AA30L-PP-15

w/15" Extension and Adjustable ConeJet Tip



MFG Part #	Description
AA30L-PP	Without Extension or Tip
AA30L-PP-15	W/ 15" Extension & Adj. Tip

# HIGH PRESSURE SPRAY WANDS

## AA23H GUNJET SERIES SPRAY WAND

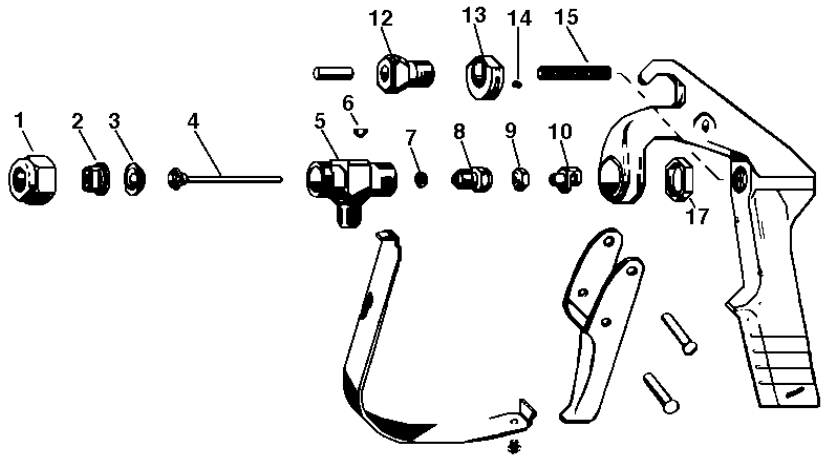

Instant shut-off with valve seat directly behind orifice tip. Use with any TeeJet Tip and with low and high pressure. Flow rates to 5 GPM. With comfortable trigger grip. Trigger guard helps prevent accidental discharge. Trigger lock holds trigger in "off" position. 1/4" NPS (M) inlet connection.

**NOTE:**  
Slide #14255-1 cup packing onto stem before inserting packing completely into inlet body, making sure cupped side of packing is facing inlet body.

**CAUTION:**  
Extra care should be taken to prevent damage to packing from threads on stem and inlet body.

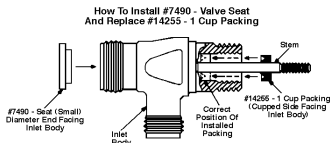

Ref #	FIMCO Code #	MFG Part #	Description
1	5046082	CP7890-NP	Cap Brass - I.N.P.
2			Spray Tip (Order By No.)
*3	5115025	CP7490-BRTF	Valve Seat, Teflon
*4	Available In Kit Only		Main Stem Assembly
5	5002356	CP16052-NP	Inlet Body
6	5089030	CP7892-IZP	Key
*7	Available In Kit Only		Packing Cup
8	5117137	CP16071-NP	Packing Screw
9	5006064	CP7484-SS	Stem Nut
10	5077009	CP7481-INP	Trigger Guide
12	5117138	CP9421-INP	Safety Lock
13	5045010	CP39698-NY	Safety Lock Cam
14	5117139	CP9423-I	Set Screw
*15	Available In Kit Only		Main Spring
17	5006065	CP7486-IENP	Lock Nut
	5168238	PK-AB23H-KIT	Repair Kit Marked*
	5010101		Swivel - 1/4FNPT x 1/4FNPS (Does Not Swivel After Tight)
	5057086	11990-10	Swivel 1/4FNPT x 1/4FNPS

FIMCO Code #	MFG Part #	Description
5271814	AA23H	Gunjet w/Cap less tip

## NO. AA31 GUNJET

For flow rates up to 5 GPM. No. 31 for pressures up to 500 P.S.I. Comfortable palm fitting gun. For use with any TeeJet spray tip. 1/4" NPS (M) inlet connection.

FIMCO Code #	MFG Part #	Description
5163015	AA 31	Wand, Less Tip
5163016	*AA 31TL	Wand, Less Tip
	PK-AB31-KIT	Kit

\*Trigger Lock Included



## SWIVELS FOR GUN CONNECTIONS

Ref #	FIMCO Code #	Description
1	5057086	(11990-10)1/4" FNPS x 1/4 FNPT Female Brass Swivel
2	5010101	Connector 1/4" FNPS x 1/4" FNPT Female (Does Not Swivel after tight)

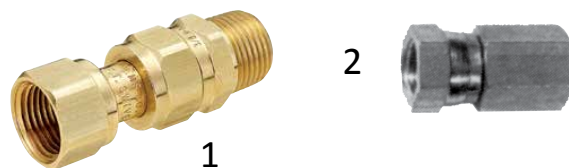

# SPRAY WANDS

## SPRAY WAND NO. 22670



### 22670-PP Includes:

- 22650 Triggerjet Spray Wand (1/4" FNPT Only)
- 15" or 24" Extension Wand
- 8079 50 Mesh Strainer
- 5500 PPB-X8 Adjustable Conejet Spray Tip
- Straight and 45° adapter
- Maximum Operating Pressure 150 PSI

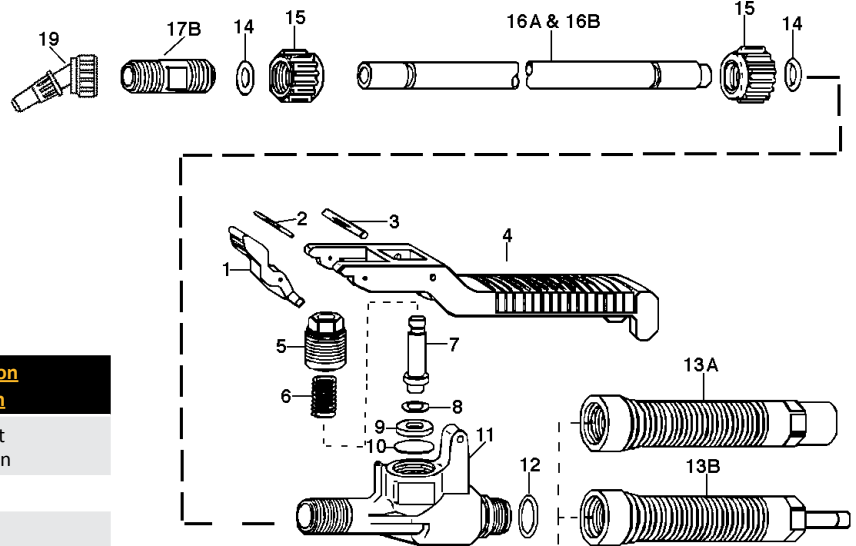

FIMCO Code #	MFG Part #	Extension Length
5163040	22650-PP-1/4	Without Extension
5163034	22670-PP-15 1/4	15"
5272927	22670-PP-24 1/4	24"

Ref #	FIMCO Code #	MFG Part #	Description
1	5077031	CP22656-NY	Trigger Lock
2	5101129	CP22671-IZP	Groove Pin
3	5101130	CP22672-IZP	Groove Pin
4	5092007	CP22655-PP	Trigger
5	5108060	CP22658-PP	Spring Retainer
*6	Available In Kit Only Marked *		
7	5132054	CP22657-NY	Stem
*8	Available In Kit Only Marked *		
9	5016186	CP22659-PP	Washer
*10	Available In Kit Only Marked *		
11	5002394	CP22651-PP	Body
*12	Available In Kit Only Marked *		
13A	5078133	CP22654-PP	Handle (1/4" NPT (F) Conn. Poly
13B	5078168	CP22653-1/4-PP	Handle (with 1/4" hose shank Conn.) Poly

Ref #	FIMCO Code #	MFG Part #	Description
*14	Available In Kit Only Marked *		
15	5046122	CP22668-PP	Cap, (2 Required)
16A	5065039	CP22663-15-FRP	Extension Tube, 15"
16B	5065043	CP22663-24-FRP	Extension Tube, 24"
17A	5005187	CP22673-PP	45° Adapter
17B	5005188	CP22664-PP	Straight Adapter
	5065045	22665-15-PP	Extension Tube Sub-Assembly, 15" (Includes 14, 15, 16A, 17A & 17B)
	5065046	22665-24-PP	Extension Tube Sub-Assembly, 24" (Includes 14, 15, 16A, 17A & 17B)qw
19	5018312	38720-PPB-X8	Nozzle Assembly
19	5018313	38720-PPB-X18	
	7771187	PK-AB22670-PP-KIT	

# SPRAYING INFORMATION

## Useful Formulas

$$\text{GPM (Per Nozzle)} = \frac{\text{GPA} \times \text{MPH} \times \text{W}}{5,940}$$

$$\text{GPM (Per Nozzle)} = \frac{\text{GAL}/1000\text{FT}^2 \times \text{MPH} \times \text{W}}{136}$$

$$\text{GPA} = \frac{5,940 \times \text{GPM (Per Nozzle)}}{\text{MPH} \times \text{W}}$$

$$\text{GAL}/1000\text{FT}^2 = \frac{136 \times \text{GPM (Per Nozzle)}}{\text{MPH} \times \text{W}}$$

GPM – Gallons Per Minute

GPA – Gallons Per Acre

GAL/1000FT<sup>2</sup> – Gallons Per 1000 Square Feet

MPH – Miles Per Hour

W – Nozzle spacing (in inches) for broadcast spraying

– Spray width (in inches) for single nozzle, band spraying or boomless spraying

– Row spacing (in inches) divided by the number of nozzles per row for directed spraying

## Nozzle Spacing

If the nozzle spacing on your boom is different than those tabulated, multiply the tabulated GPA coverages by one of the following factors.

20'	
Other Spacing (Inches)	Conversion Factor
8	2.5
10	2
12	1.67
14	1.43
16	1.25
18	1.11
22	.91
24	.83
30	.66

## Useful Formulas for Roadway Applications

$$\text{GPLM} = \frac{60 \times \text{GPM}}{\text{MPH}} \quad \text{GPM} = \frac{\text{GPLM} \times \text{MPH}}{60}$$

GPLM = Gallons Per Lane Mile

**Note:** GPLM is not a normal volume per unit area measurement. It is a volume per distance measurement. Increases or decreases in lane width (swath width) are not accommodated by these formulas.

## Measuring Travel Speed

Measure a test course in the area to be sprayed or in an area with similar surface conditions. Minimum lengths of 100 and 200 feet are recommended for measuring speeds up to 5 and 10 MPH, respectively. Determine the time required to travel the test course. To help ensure accuracy, conduct the speed check with a partially loaded (about half full) sprayer and select the engine throttle setting and gear that will be used when spraying. Repeat the above process and average the times that were measured. Use the following equation or the table at right to determine ground speed.

$$\text{Speed (MPH)} = \frac{\text{Distance (FT)} \times 60}{\text{Time (seconds)} \times 88}$$

## Speeds

Speed in MPH	Time Required in SECONDS to Travel a Distance of:		
	100 Feet	200 Feet	300 Feet
1.0	68	136	205
1.5	45	91	136
2.0	34	68	102
2.5	27	55	82
3.0	23	45	68
3.5	19	39	58
4.0	17	34	51
4.5	15	30	45
5.0	14	27	41
5.5	—	25	37
6.0	—	23	34
6.5	—	21	31
7.0	—	19	29
7.5	—	18	27
8.0	—	17	26
8.5	—	16	24
9.0	—	15	23

30'	
Other Spacing (Inches)	Conversion Factor
26	1.15
28	1.07
32	.94
34	.88
36	.83
38	.79
40	.75
42	.71
44	.68

40'	
Other Spacing (Inches)	Conversion Factor
28	1.43
30	1.33
32	1.25
34	1.18
36	1.11
38	1.05
42	.95
44	.91
48	.83

## Miscellaneous Conversion Factors

One Acre = 43,560 Square Feet  
= 43.56 1000FT<sup>2</sup> Blocks  
= 0.405 Hectare

One Hectare = 2.471 Acres

One Gallon Per Acre

= 2.9 Fluid Ounces per 1000FT<sup>2</sup>  
= 9.35 Liters Per Hectare

One Gallon Per 1000FT<sup>2</sup> = 43.56 GPA

One Mile = 5,280 Feet

= 1,610 Meters  
= 1.61 Kilometers

One Gallon = 128 Fluid Ounces

= 8 Pints  
= 4 Quarts  
= 3.79 Liters  
= 0.83 Imperial Gallon

One Pound Per Square Inch

= 0.069 bar  
= 6.896 Kilopascals

One Mile Per Hour

= 1.609 Kilometers Per Hour

## Suggested Minimum Spray Heights

The nozzle height suggestions in the table below are based on the minimum overlap required to obtain uniform distribution. However, in many cases, typical height adjustments are based on a 1 to 1 nozzle spacing to height ratio. For example, 110° flat spray tips spaced 20 inches apart are commonly set 20 inches above the target.

	Nozzle Orientation	Nozzle Height (Inches)		
		20'	30'	40'
TeeJet® Standard, TJ	65°	22–24"	33–35"	NR*
TeeJet, XR, TX, DG, TJ	80°	17–19"	26–28"	NR*
TeeJet, XR, DG, TT, TTI, TJ, DGTJ, AI, AIXR	110°	16–18"	20–22"	NR*
FullJet®	120°	10–18"***	14–18"***	14–18"***
FloodJet® TK, TF	120°	14–16"****	15–17"****	18–20"****

\* Not recommended.

\*\* Nozzle height based on 30° to 45° angle of orientation (see page 284 of catalog).

\*\*\* Wide angle spray tip height is influenced by nozzle orientation. The critical factor is to achieve a double spray pattern overlap.



# SPRAYING INFORMATION

## SIZE SELECTION OF SPRAY TIP OR NOZZLE

Based on the chemical manufacturer's recommendations on GPA application rates and nozzle types, a suitable spray tip size is chosen from the catalog tabulations. Since all the tabulations are based on spraying water, which weighs 8.34 lbs. per USA gallon, conversion factors must be used when spraying solutions which are heavier or lighter than water. Using conversion factors from the tables below multiply by the catalog tabulated GPM and GPA rates - to arrive at the values for the solution to be sprayed.

Weight of solution	Specific Gravity	Conversion Factors
7.0 lbs. per gallon	.84	.92
8.0 lbs. per gallon	.96	.98
8.34 lbs. per gallon - WATER	1.00	1.00
9.0 lbs. per gallon	1.08	1.04
10.0 lbs. per gallon	1.20	1.10
10.65 lbs. per gallon - 28% nitrogen	1.28	1.13
11.0 lbs. per gallon	1.32	1.15
12.0 lbs. per gallon	1.44	1.20
14.0 lbs per gallon	1.68	1.30

## BEFORE YOU GO INTO THE FIELD

Check all your equipment - make certain that all components are clean including the tank, pump, control valves, check valves, hoses, boom, strainers, nozzles, and spray tips. **WARNING:** never use a metal object in cleaning nozzle orifices. Use a plastic or wooden probe.

Check the flow rate from all nozzles using a master pressure gauge mounted in the boom close to the nozzles. (After the test remove the master pressure gauge and plug the connection). While this nozzle flow test is being conducted, check the pressure reading on the rig pressure gauge to compare its reading to the pressure at the nozzles. The flow rates can be determined from the flow charts contained in this catalog. Remember, the catalog tabulations are based on pressures at the nozzles.

**NOTE:** If the ball type check valves are used, the actual nozzle pressure will be approximately 5 P.SI. lower than the gauge reading, depending on spring rating and flow rate.

## CHOICE AND CARE OF SPRAY EQUIPMENT

All the factors in today's spraying application, including chemical costs, pollution and driftage control, point to the importance of choosing the proper spray equipment and maintaining it in an efficient operating order. Therefore, the original purchased equipment should be made of materials which resist corrosion and wear such as stainless steel spray tips. Since usage of spray nozzles usually brings about orifice clogging problems, erosion, etc., it is very important that the tips be cleaned after each operation, and tested before using again. Finally even when using precision spray tips, it is necessary to control all the other factors in the spraying application - such as rig speed, spraying pressure, spray height, etc., in order to place the proper amount of chemicals in the proper areas. An established routine of proper maintenance will soon pay for itself.

## AFTER SPRAYING

Rinse And Clean All The Spraying equipment - including the spray tips, being careful not to use a metal probe in the orifice. This cleaning routine is especially important after spraying wettable powders. Wash spray tips thoroughly with water or cleaning solution (appropriate for chemical sprayed). Blow out orifice clean and dry. If orifice remains clogged, clean it with a fine bristle (not wire) brush or with a toothpick. Do not damage the orifice. Water - rinse and dry tips before storing.



# WEIGHTS & MEASUREMENTS

Model #	Item #	UPC	Length	Width	Height	Weight	Quantity per Pallet
LWN-GRD-4	5303079	733029119995	14	11	23	11	44
LG-5-P	5302165	733029002211	21	18	23	33	12
LG-8-P	5302164	733029007841	19	17	23	26	16
LG-10-EC	5301547	733029005250	31	14	13	12	28
15-SP-GS-B	5303643	733029124753	48	34	40	140	18
15-SP-GS	5303644	733029124760	32	15	16	15	24
LG-15-EC	5301302	733029003058	34	16	15	18	24
LG-13-P	5300393	733029001009	34	16	14	20	24
LG-14-PM	5301144	733029002549	34	16	15	21	24
LG-14-SM	5301145	733029002556	34	16	15	21	24
LG-20-EC	5301548	733029005267	38	18	15	20	15
25-SP-GS	5303645	733029124777	32	15	21	20	15
LG-25-EC	5301378	733029003195	39	19	16	22	15
LG-29-P	5300632	733029001443	39	19	16	24	15
LG-28-S	5301063	733029002310	39	19	16	25	15
LG-25-PM	5301146	733029002563	39	19	16	24	15
LG-25-SM	5301147	733029002570	39	19	16	25	15
LG-25-HV	5301222	733029002990	39	19	16	25	15
LG-30-EC	5301561	733029005472	42	20	17	26	12
LG-30-S	5301478	733029004246	42	20	17	26	12
LG-40-DLX	5302186	733029107336	30	28	24	30	12
LG-45-SS	5303260	733029123800	38	24	22	32	8
LG-65-HP	5303623	733029123824	45	26	24	40	4
BR-15-SP-EC	5303152	733029121561	34	16	15	18	18
BR-25-SP-EC	5303153	733029120755	32	15	21	23	12
BR-40-SP-EC	5303154	733029121578	30	28	24	30	12
15-2N-TRL-GS	5303198	733029122056	40	16	16	42	15
LG-20-TRL	5302316	733029110008	36	20	17	46	8
25-2N-TRL-GS	5303199	733029122063	40	16	22	55	8
25-3N-TRL-GS	5303649	733029124784	40	16	22	43	12
LG-30-TRL	5302317	733029110015	45	20	20	58	8
TRL-45-12V-4	5303635	733029124135	40	24	26	103	6
TRL-65-12V-BL	5303638	733029124470	47	35	29	144	2
TRL-65-12V-7	5303637	733029124463	47	35	29	153	2
TRL-65-4R-BL	5303640	733029124494	74	27	31	214	2
TRL-65-4R-7	5303639	733029124487	74	27	31	230	2
FT-200-4R	5303634	733029123909	86	62	60	500	1
ATVTS-200-4R-BL	5303223	733029122339	86	62	60	550	1
15-2N-ATV-GS	5303197	733029122049	34	16	16	26	15
ATV-15-2-QR	5302318	733029110022	34	16	15	26	10
ATV-20-2-QR	5302319	733029110039	38	18	15	27	10
25-3N-ATV-GS	5303648	733029124814	40	16	22	30	12
ATV-25-700-QR	5302320	733029110046	56	19	21	56	8
ATV-25-71-QR	5302321	733029110053	56	19	21	65	8
LG-25-BL-QR	5302323	733029110077	39	19	16	37	10
LG-3025-QR	5302322	733029110060	39	19	16	35	10
45-3N-UTV-GS	5303650	733029124791	38	24	22	45	8
UTV-45-BL	5302865	733029114822	37	31	18	68	4
UTV-45-7	5302864	733029114839	47	31	19	85	4
65-5N-UTV-GS	5303651	733029124807	45	26	24	56	4
UTV-65-BL	5302843	733029114327	48	36	19	85	4
UTV-65-7	5302830	733029114433	48	36	19	97	4
UTV-HR-50	5302886	733029115003	34	17	14	32	12
30-3N-3PT-GS	5303678	733029124951	38	24	22	60	6
3PT-45-12V-4	5303244	733029122711	40	24	26	90	6
3PT-45-12V-BL	5303245	733029122728	40	24	26	80	6
3PT-65-12V-BL	5303251	733029122643	47	33	39	121	2

# WEIGHTS & MEASUREMENTS

Model #	Item #	UPC	Length	Width	Height	Weight	Quantity per Pallet
3PT-65-12V-7	5303250	733029122636	47	33	39	137	2
3PT-65-NR-BL	5303255	733029122698	47	33	39	127	2
3PT-65-NR-7	5303254	733029122681	47	33	39	143	2
3PT-65-6R-BL	5303253	733029122650	47	33	39	135	2
3PT-65-6R-7	5303252	733029122629	47	33	39	151	2
3PT-110-NR-1025FX4	5303765	733029126344	51	46	89	310	1
3PT-110-6R-2BB	5303764	733029126337	51	46	50	285	1
3PT-110-6R-1025FX4	5303763	733029126313	51	46	89	320	1
3PT-200-NR-1225FX4	5303769	733029126382	51	46	89	400	1
3PT-200-8R-2BB	5303768	733029126375	51	46	60	375	1
3PT-200-8R-1225FX4	5303767	733029126368	51	46	89	415	1
3PT-300-NR-1725FX5	5303773	733029126429	90	48	60	540	1
3PT-300-8R-2BB	5303772	733029126412	90	48	60	455	1
3PT-300-8R-1725FX5	5303771	733029126405	90	48	60	555	1
SK-110-8R	5301052	733029004260	79	41	49	229	1
9-150	5300431	733029001214	79	41	49	264	1
FS-150-4R	5303066	733029119421	60	50	52	195	1
9-200	5300655	733029001603	79	41	49	270	1
LSS-280	5300467	733029001139	79	41	49	396	1
LSS-280-H	5301865	733029008749	79	41	49	235	1
LSS-280-EH	5301867	733029008763	79	41	49	235	1
LSS-240	5301259	733029004352	79	41	49	330	1
LSS-235-H	5301869	733029008787	79	41	49	235	1
TSSK-300	5301337	733029003164	105	54	54	587	1
LG-25-PRO	5302922	733029116864	32	15	21	25	12
ATV-25-700-PRO	5302927	733029117434	56	16	27	60	6
LG-3025-PRO	5302926	733029117427	38	15	27	36	12
3PT-45-PRO-4	5303246	733029122735	40	24	26	90	6
LG-50-TRL-PRO	5302928	733029117441	56	41	29	174	2
LG-50-TRL-PRO-BL	5302930	733029117571	56	41	29	170	2
ATVBK-200-QR	5302339	733029110770	46	6	6	10	24
ATVBK-500-QR	5302338	733029110763	55	11	6	23	24
ATVBK-700-QR	5302337	733029110756	55	11	6	27	24
ATVBK-710-QR	5302336	733029110749	55	11	6	31	24
ATVBK-3025-QR	5302334	733029110725	55	11	6	11	24
TC-10-18	5301546	733029005243	44	34	14	103	5
TC-17	5301397	733029003331	61	39	17	200	4
TC-17-4	5301398	733029003348	61	39	17	227	4
TC-10-P	5301461	733029003614	49	36	14	75	7
TC-10P-EC-B	5302051	733029010605	49	36	14	70	6
TC-10-EC	5301841	733029008589	49	36	60	575	8
TC-15-HP	5302027	733029010469	48	40	15	85	5
DTH-42	5301491	733029004581	50	13	11	50	18
SPK-42	5301531	733029005199	51	18	14	85	10
PLG-42	5301530	733029005182	51	18	14	85	10
LRP-1824	5301944	733029009296	32	20	18	42	10
LRP-1836	5301945	733029009302	44	20	18	51	8
LRP-1848	5301946	733029009319	57	20	18	63	8
LRP-2436	5301947	733029009326	44	25	25	76	3
LRP-2448	5301948	733029009333	56	25	25	84	3
LRS-2436	5301949	733029009340	44	25	25	163	3
LRS-2448	5301950	733029009357	56	25	25	189	3
ATV-DMS-12V	5301845	733029008633	29	21	22	53	9
ATV-DMS-12V-2RC	5302957	733029119216	29	21	22	55	9
DMS-TR-12V-2.2	5302028	733029010476	29	20	26	69	9
DMS-TR-12V-5.0	5302035	733029010544	40	44	36	110	2
DMS-3PT-12V-4.5	5302045	733029010551	40	26	36	90	2

\*\*\*\*\* Commercial and Residential Shipping Rates Vary \*\*\*\*\*

Doesn't include pallet weight

## OWNER'S MANUAL

**Model: UTV-65-7-PRO (5303071)**

(65 Gallon Lawn & Garden UTV Sprayer w/7-Nozzle Boom)

**Professional Grade Pump (4.0 GPM):**  
Ideal for Harsh Chemicals & Oil  
Based Chemicals with Surfactants

**Long Range 13" PRO SERIES Handgun**  
38' Horizontal Spray & 27' Vertical

Roundup® Ready

### Technical Specifications

- 65 Gal. Corrosion-Resistant Polyethylene Tank
- 13" Pro Series Handgun w/25 Ft. Handgun Hose
- 7-Nozzle Boom Assembly (140" Spray Coverage)
- Drift Reducing Corrosion-Resistant Nylon Nozzles w/"No-Drip" Check Valve Strainers
- Adjustable Boom Height
- Pro Series 4.0 GPM, 45 PSI, 12 Volt Diaphragm Pump
- Multi-Lid to accurately measure and dispense

### General Information

Thank you for purchasing this product. This manual is to assist you in operating and maintaining your UTV sprayer.

**WARNING:** To reduce the risk of injury, you must read and understand the operator's manual before using this product.

**WARNING:** Cancer and Reproductive Harm  
[www.P65Warnings.ca.gov](http://www.P65Warnings.ca.gov)

BEFORE RETURNING THIS PRODUCT FOR ANY REASON, PLEASE CALL  
**1-800-831-0027**  
MONDAY-FRIDAY, 8:00 AM TO 5:00 PM CST

If you should have a question or experience a problem with your Fimco Industries Product: Visit our website @ [www.fimcoindustries.com](http://www.fimcoindustries.com) or call the Toll free number above. Our technical support representatives will be happy to help you. In most cases a customer service representative can resolve the problem over the phone.

To obtain prompt, efficient service, always remember to give the following information...  
• Correct Part Description and/or part number  
• Model number and Serial Number  
Part descriptions and numbers can be obtained from the illustrated parts list section(s) of this manual.

**Retain a copy of your receipt for your unit, as it will be required to validate any warranty service.**

**Warranted against manufacturer or workmanship defects from date of purchase with copy of receipt:**

Homeowner Usage: One Year

Commercial Usage: 90 Days

## OWNER'S MANUAL

**Model: LG-30-TRL (5302317)**

(30 Gallon Lawn & Garden Trailer Sprayer)

### Technical Specifications

- 30 Gal. Corrosion-Resistant Polyethylene Tank
- 12 Volt Diaphragm Pump, 2.4 GPM - 60 PSI
- 15 Ft. Handgun Hose
- 25 Ft. max. vertical throw, 40 Ft. horizontal throw
- 2-Nozzle Break-Away Boom Assembly (80" Spray Coverage)
- Corrosion-Resistant Nylon Nozzles
- Check Valve Strainers, 50 Mesh, 5 PSI
- Easy access drainage port (Complete Drain Out)
- Front forward gun and hose wrap for easier access from transport vehicle
  - Heavy Duty 16" tires
  - Wide Axle
  - Streamlined tank design for compact storage and shorter turning radius

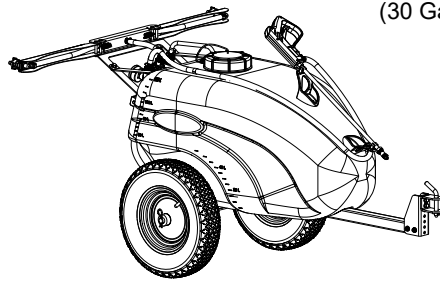

### General Information

Thank you for purchasing this product. The purpose of this manual is to assist you in operating and maintaining your lawn & garden Trailer sprayer.

**WARNING:** To reduce the risk of injury, the user must read and understand the operator's manual before using this product.

**WARNING:** Cancer and Reproductive Harm  
[www.P65Warnings.ca.gov](http://www.P65Warnings.ca.gov)

BEFORE RETURNING THIS PRODUCT FOR ANY REASON, PLEASE CALL  
**1-800-831-0027**  
MONDAY-FRIDAY, 8:00 AM TO 5:00 PM CST

If you should have a question or experience a problem with your Fimco Industries Product: Visit our website @ [www.fimcoindustries.com](http://www.fimcoindustries.com) or call the Toll free number above. Our technical support representatives will be happy to help you. In most cases a customer service representative can resolve the problem over the phone.

To obtain prompt, efficient service, always remember to give the following information...  
• Correct Part Description and/or part number  
• Model number and Serial Number  
Part descriptions and numbers can be obtained from the illustrated parts list section(s) of this manual.

**Retain a copy of your receipt for your unit, as it will be required to validate any warranty service.**

**Warranted against manufacturer or workmanship defects from date of purchase with copy of receipt:**

Homeowner Usage: Sprayer-One Year and Pump-Two Years.

Commercial Usage: Sprayer and Pump-90 Days.



**Caution: Always check the vehicle load rating before using the sprayer. The loaded weight of this sprayer and boom assembly is approx.: 320 lbs. when the tank is full.**

**NOTE:** Maximum Speed - 5 MPH  
Refer to vehicle's manual for towing instructions

### Assembly Instructions

- Make sure the contents of the sprayers carton match the items shown on page 2 of the manual.
- Follow the steps on pages 3 & 4 to properly assemble the sprayer.

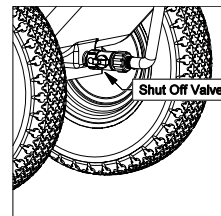

### IMPORTANT:

This sprayer comes with an On/Off (shut-off) valve located at the inlet location of the tank, towards the underside. You must make sure the valve is in the "open" position before using your sprayer.



[www.fimcoindustries.com](http://www.fimcoindustries.com)

1000 FIMCO Lane, P.O. Box 1700, North Sioux City, SD 57049  
Toll Free Phone: 800-831-0027 : Toll Free Fax: 800-494-0440  
[5194822 (02/20)]

# PRODUCT MANUALS & PARTS BREAKDOWNS

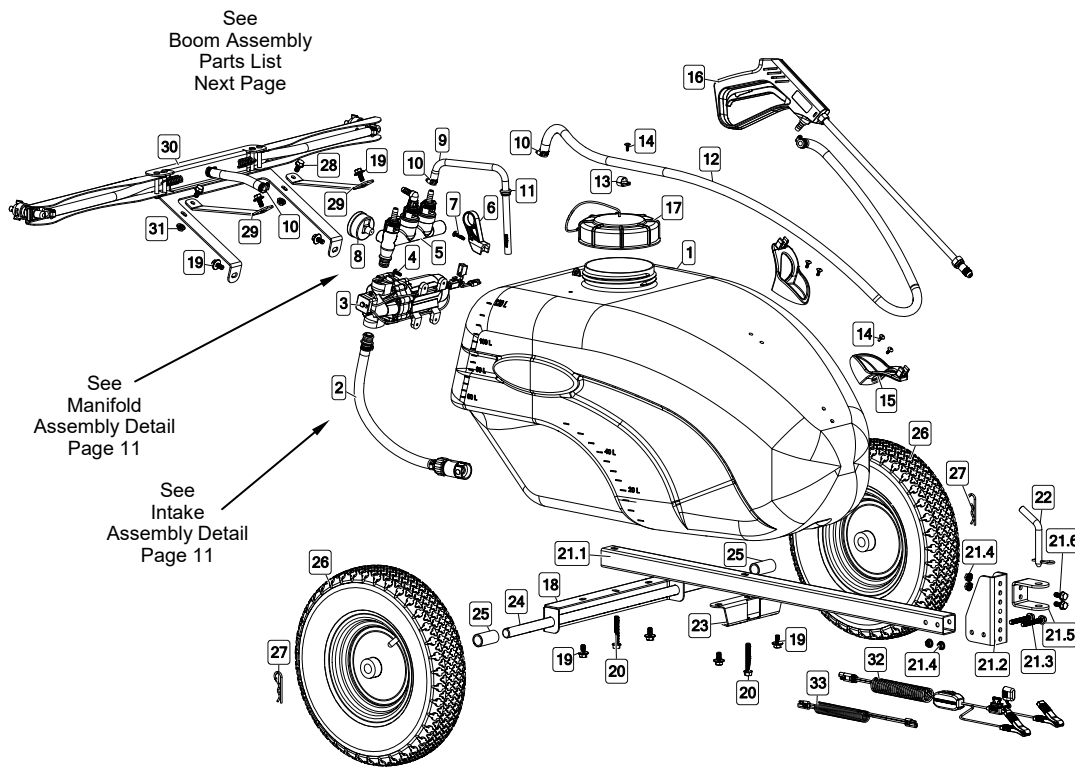

Exploded View/Parts List: LG-30-TRL (5302317)

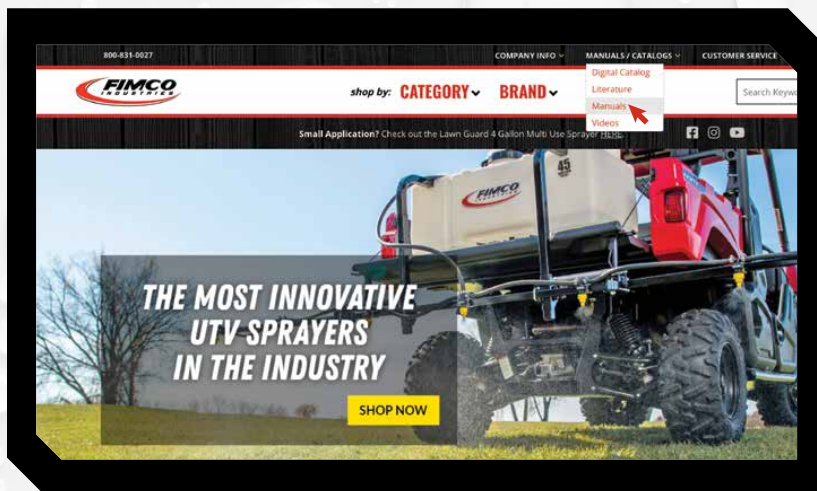

**FIMCO PRODUCT MANUALS  
& PARTS BREAKDOWNS  
CAN BE FOUND AT  
[FIMCOINDUSTRIES.COM/MANUALS](https://www.fimcoindustries.com/manuals)**



# **POLICIES, TERMS & CONDITIONS**

## **THANK YOU**

We at Fimco Industries want to express our appreciation for the business you have given us. We are committed to building high quality sprayers and providing a combination of high caliber product lines, knowledgeable sales staff and prompt service all at competitive prices. We will continue to do our very best to provide the same high standards of product and service you have come to expect from us.

## **LIMITED WARRANTY**

All warranties are subject to the warranty of the original manufacturer. Fimco Industries' products are warranted for one year from date of purchase against material or workmanship defects for personal or homeowner usage. Fimco Industries products are warranted for 90 days for commercial users. Any unauthorized modification of a Fimco product will void the warranty. Warranty claims will be processed by Fimco Industries after the items are returned freight prepaid to the Fimco Industries location where the product was purchased. Examination and determination of warranty, if applicable, will be subject to and limited by the warranty of the original manufacturer. Fimco Industries assumes no liability for any unwarranted equipment. All items must be returned within 30 days of failure.

## **LIQUID CARRYING VESSEL WARRANTY**

Liquid carrying vessels are subject to the applicable warranty only. The loss of chemicals within the vessel is not covered by warranty. Expenses, inconveniences or other damages that may occur are not subject to warranty consideration. The warranty is void if the vessel or vessel lining failed because of inadequate support of the vessel, misuse or lack of reasonable care or use of chemical formulations not recommended by the vessel manufacturer. The user shall check all labels for the information on known chemicals that are detrimental to vessel or vessel lining. The user shall determine the suitability of the product for his intended use and assume all risks and liability in connection therewith. The entire limited warranty is embodied in this writing. Fimco Industries neither assumes nor authorizes any person to assume for it any other liability in connection with its equipment.

## **RETURN FOR CREDIT**

Merchandise may be returned for credit only upon authorization by Fimco Industries. Upon authorization, merchandise must be returned freight prepaid within 30 days of purchase. All returns must specify the invoice number and the date the items were purchased. Credit will be issued for the net invoice cost less all allowances, freight charges, a handling charge and additional charges for any items not received in saleable condition. Special orders cannot be returned. The final credit issued, in any event, will be subject to Fimco Industries inspection to determine condition.

## **CHECK MERCHANDISE IMMEDIATELY UPON RECEIPT**

If a shipment is received in bad condition or there is a shortage, note this fact on the carriers receipt. Report any problems to Fimco Industries immediately.

## **PRICES**

Prices shown are FOB Fimco Industries or FOB manufacturer and are current to the best of our knowledge. However, prices may change at any time without notice or obligation as some of our suppliers component price changes throughout the year. Prices charged will be the current pricing at the time of shipment. If you have any questions, please contact us at Fimco Industries.



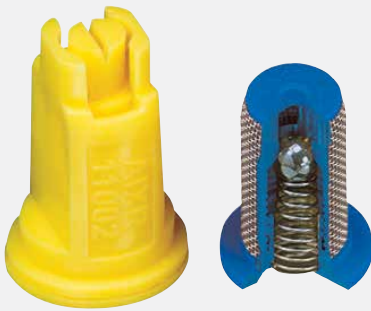

**YOUR SOURCE FOR  
SPRAYER PARTS &  
ACCESSORIES**



**2024** / **CATALOG &  
PARTS BOOK**

1000 FIMCO LN · NORTH SIOUX CITY, SD 57049  
PHONE: 605.232.6800 · FAX: 605.232.6814  
TOLL FREE: 800.831.0027 · TOLL FREE FAX: 800.494.0440  
[WWW.FIMCOINDUSTRIES.COM](http://WWW.FIMCOINDUSTRIES.COM) · [INFO@FIMCOINDUSTRIES.COM](mailto:INFO@FIMCOINDUSTRIES.COM)